

# Data Sheet

## 6W LED G5.3 Reflector

Version	V2.0
File Name	Data_KTC_6W(KTC06PWR)_G5.3_2012-V2.0.doc
Location	[Root]/datasheet PDF\DataSheets PDF 2012\LED\PowerSpot.KTC MR16

### CONTENTS

CONTENTS .....	1
Photograph.....	2
Product Code Format.....	2
Features .....	2
Specifications .....	3
Compatibility.....	4
Lumen Output Vs. Temperature .....	5
Lumen Maintenance.....	5
Photometrics .....	6
Line Drawing .....	6
Packaging .....	7

### History

Version	Date	Comment	Written By	Review By
V1.0	2011-10-12	First Release	L.Cheng	W. Kuang
V1.1	2012-03-15	First Edit	J.Kent	W. Kuang
V2.0	2012-05-10	Second Release	J.Kent	W. Kuang

Authorised By	
Position	
Signature	



## Specifications

Rated Lamp Wattage	6W	Peak Candelas	1000cd (3000K)
Equ. Wattage	50W		1060cd (4000K)
Input Voltage	12VDC/AC		1200cd (6500K)
Quantity of LED(pcs)	4	Ambient Temperature(Ta)	-20°C to 40°C
Dimmable	No	Case Temperature(Tc)	Max. 70°C
Base	G5.3	LED Chip	Epistar
Beam Angle	30°	Length	54.5mm
Life to 50% Failure	35000h	Diameter	50mm
Colour Temperature	3000K/4000K/6500K	Packaging Type	Colour Box
CRI	76 Ra	Qty Per Box	1
Lamp Luminous Flux	320lm (3000K)	Qty Per Mid-Carton	20
	330lm (4000K)	Qty Per Carton	100
	370lm (6500K)	Net Weight Per Piece	75g
Lumen Maintenance 10000h	91%	Gross Weight Per Carton	7.5 kg
Lumen Maintenance 35000h	80%		

## Compatibility

The lamps can be used with most 12V AC electronic transformers for LV-Halogen lamps in the 20-60VA range but it is always recommend that lamps are tested with existing transformers before committing to an installation. Test results in laboratory conditions are listed below for a limited number of transformers. Unless otherwise indicated the test was performed on a one-to-one basis.

<b>Make</b>	<b>Model</b>	<b>Rating</b>	<b>KTC06PWR/G5.3</b>
AURORA	AU-150SS	50-150VA	OK small buzzing
AURORA	AU-210SS	50-210VA	OK small buzzing
AURORA	AU-RD105	35-105VA	OK small buzzing
AURORA	DAIS DA-E60	20-60VA	OK
AURORA	ENLITE EN-SC60	20-60VA	OK (1-3)
AURORA	AU-RD60E	20-60VA	OK
AVENUE	AVET60MINI	60VA	OK
COLLINGWOOD	SET105FS	35-105VA	OK
COLLINGWOOD	BLACK60	20-60VA	OK
COLLINGWOOD	GREEN60	20-60VA	OK
CONTACT	CED-60	20-60VA	NO
HALOLITE	HA-SF60T	20-60VA	OK
HALOLITE	HA-SM60TS	20-60VA	OK small buzzing
HALOLITE	HA-SE60	20-60VA	OK
HALOLITE	HA-S60TA	20-60VA	NO
JCC	JC4013	35-105VA	OK
JCC	JC4030	10-60VA	OK
KNIGHTSBRIDGE	T02	20-60VA	OK
LL	ET105	20-105VA	OK
LUXINA	ET60T-3	20-60VA	OK
MAE	MA-60	10-60VA	OK
OSRAM	HTM 70/230-240	20-70VA	OK
ROBUS	LEB60D	20-60VA	OK
VARILIGHT	YT250	0-250VA	OK
VARILIGHT	YT105L	0-105VA	OK
VARILIGHT	YT70L	0-70VA	OK
VARILIGHT	YT50L	0-50VA	OK
VARILIGHT	YT150	0-150W	OK

---

## Lumen Output Vs. Temperature

---

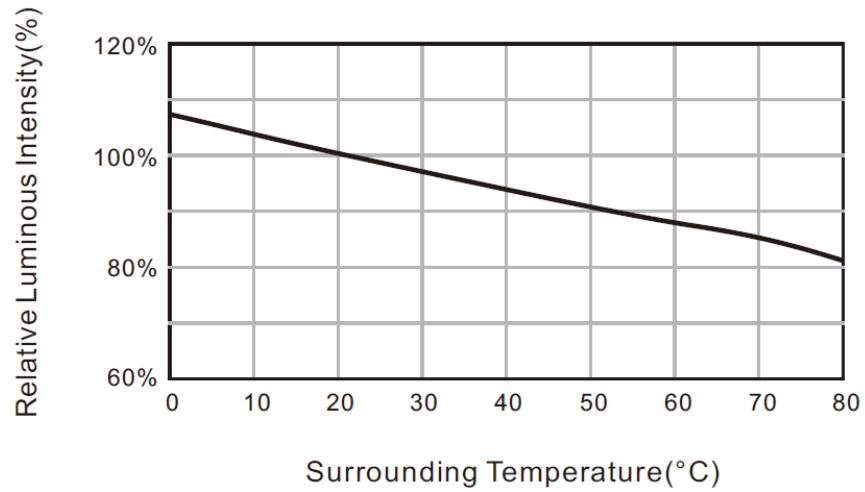

---



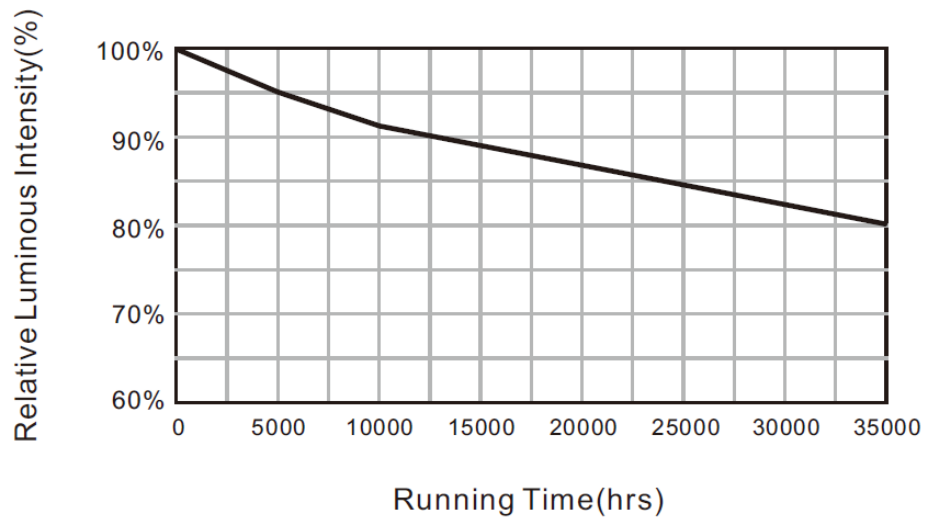

## Lumen Maintenance

---

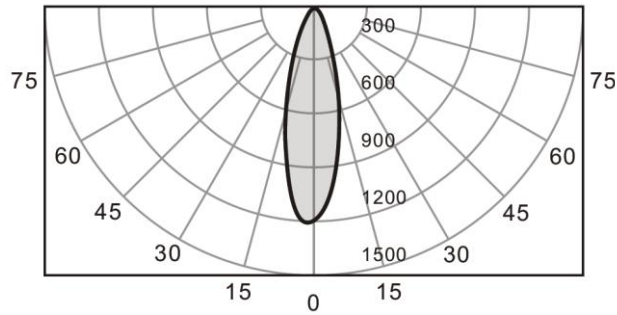

## Photometrics

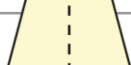

m	Beam Angle: 30°	Lux	∅cm
0.5		5026	20
1.0		1257	42
2.0		314	84
3.0		140	126

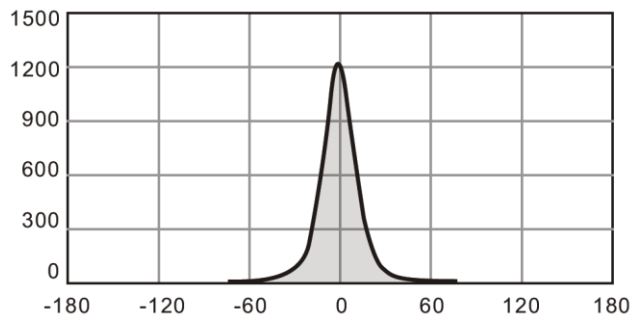

## Line Drawing

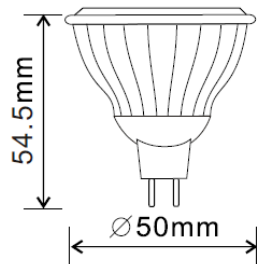

## Packaging

---

- 100 units per outer carton
- 20 units per inner carton
- 5 inner cartons per outer carton

## Dimension

---

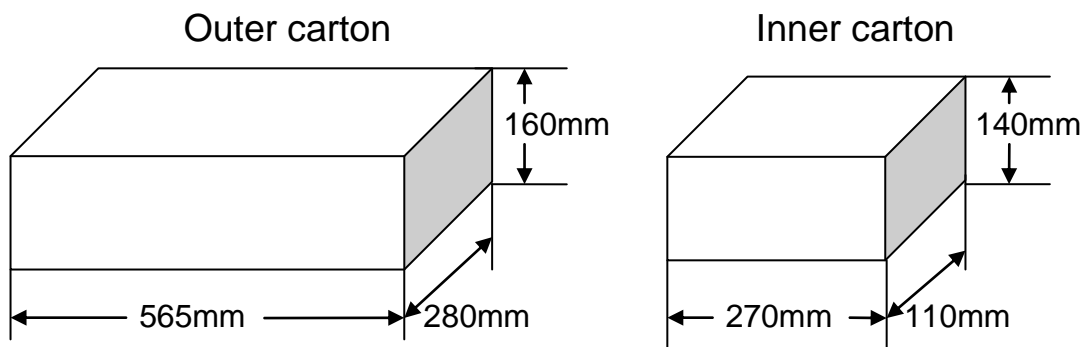

## Mark

---

Label

---



