

# Data Sheet

## 6W LED GU10 Reflector

Version	V1.0
File Name	Data_KTC_6w(KLED06PWR)_GU10_2011-V1.0.doc
Location	[Root]/Datasheet/LED/PowerSpot

### CONTENTS

CONTENTS .....	1
Photograph.....	2
Product Code Format.....	2
Features .....	2
Specifications .....	3
Lumen Output Vs. Temperature .....	4
Lumen Maintenance.....	4
Photometrics.....	5
Line Drawing .....	5
Packaging.....	6

### History

Version	Date	Comment	Written By	Review By
V1.0	2011-10-12	First Release	L.Cheng	W. Kuang

Authorised By	
Position	
Signature	

## 6W LED GU10 Reflector

KTC06PWR/GU10-S30 KTC06PWR/GU10-S40 KTC06PWR/GU10-S65

### Photograph

---



### Product Code Format

---

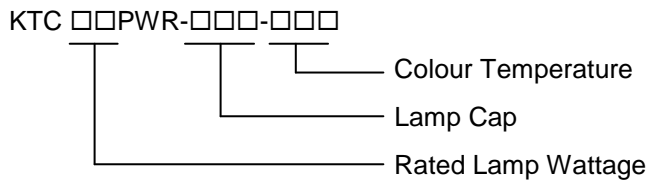

### Features

---

- Save energy up to 90% comparing with halogen lamps.
- Long Life of 35000h, 25 times longer than halogen lamp.
- Popular GU10 base and standard shape for direct replacement of halogen GU10 lamp.
- Instant start.
- Not dimmable
- No UV output.
- Lamp life may reduce when used in enclosed fitting.

## Specifications

Rated Lamp Wattage	6W	Peak Candelas	1000cd (3000K)
Equ. Watt	50W		1060cd (4000K)
Input Voltage	220-240V		1200cd (6500K)
Line Frequency	50/60Hz	Ambient Temperature(Ta)	-20°C to 40°C
Input Current	50mA	Case Temperature(Tc)	Max. 70°C
Quantity of LED(pcs)	4	LED Chip	Epistar
Dimmable	No	Length	52.5mm
Base	GU10	Diameter	50mm
Beam Angle	30°	Packaging Type	Color Box
Life to 50% Failure	35000hr	Qty Per Box	1
Color Temperature	3000K/4000K/6500K	Qty Per Mid-Carton	20
CRI	76 Ra	Qty Per Carton	100
Lamp Luminous Flux	320lm (3000K)	Net Weight Per Piece	75g
	330lm (4000K)	Gross Weight Per Carton	7.5 kg
	370lm (6500K)		
Lumen Maintenance 10000h	91%		
Lumen Maintenance 35000h	80%		

---

## Lumen Output Vs. Temperature

---

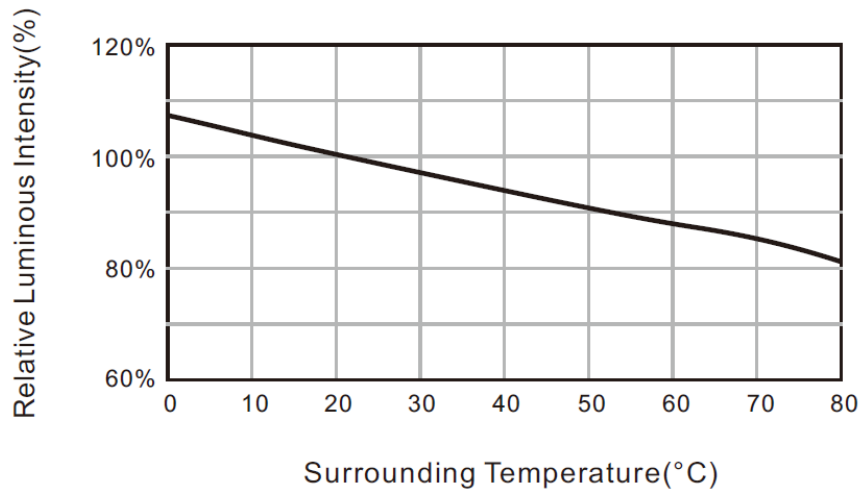

---

## Lumen Maintenance

---

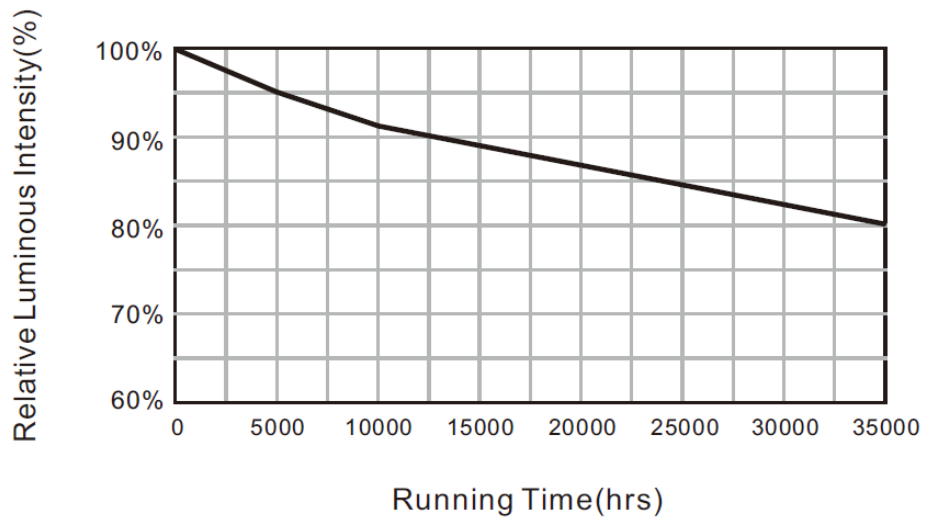

Photometrics

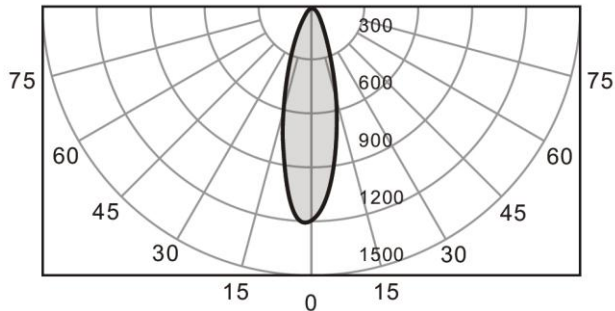

m	Beam Angle: 30°	Lux	Øcm
0.5		5026	20
1.0		1257	42
2.0		314	84
3.0		140	126

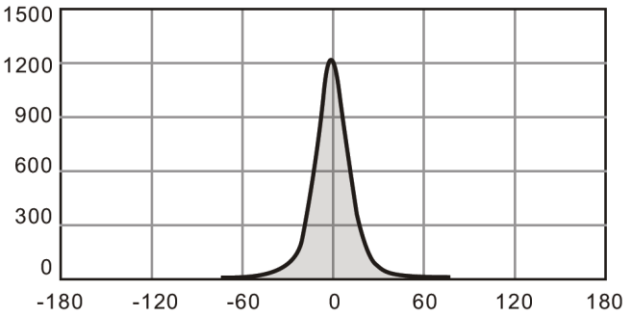

Line Drawing

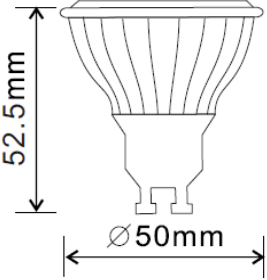

## Packaging

---

- 100 units per outer carton
- 20 units per inner carton
- 5 inner cartons per outer carton

## Dimension

---

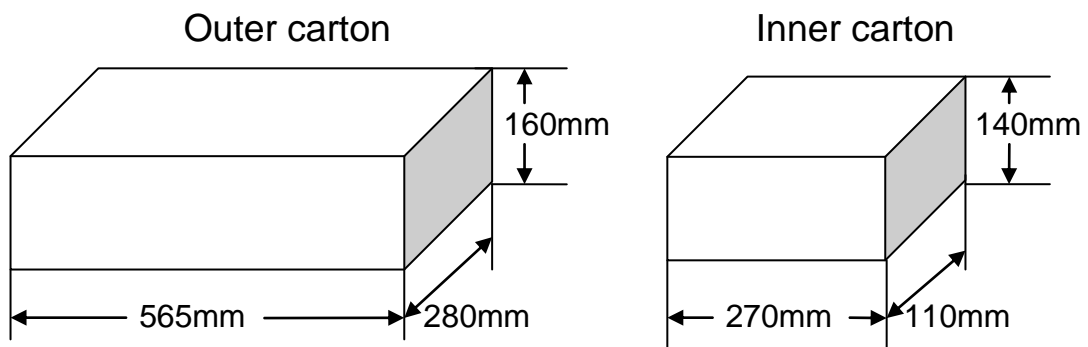

## Mark

---

Label

---

