

ROBUS®

COMMERCIAL

SPEEDBEAM PLUS

18/36W, 24/48W, 34/68W, IP20

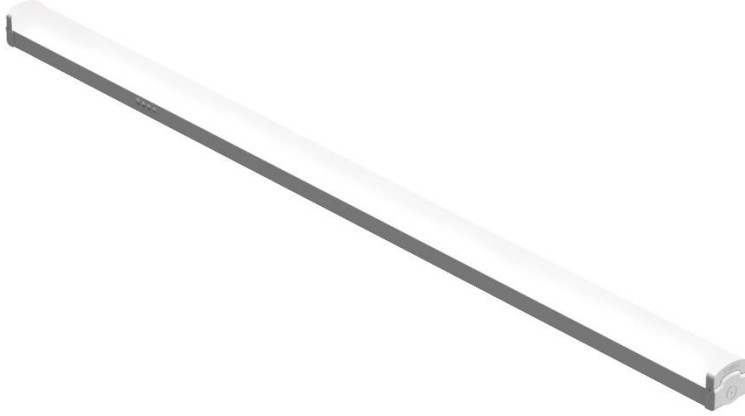

PRODUCT INFORMATION DOCUMENT

FEATURES

- Easy to open screw-less end caps providing quick and simple installation
- Two-part construction making wiring and installation much easier and faster
- Modularised components for quick and easy replacement
- All sizes equipped with quick connectors allowing plug-in emergency pack (RLEMPKDT-PSU) and plug-in microwave sensor (RLMW) to be fitted in seconds. Compatible with suspension kit (RAESUS-2W)
- Light colour temperature selectable between 3000K, 4000K and 6500K
- Unique design of each size allowing selection between 2 different lumen outputs to suit installation area requirements

CONSTRUCTION

- Pressed steel, powder coated base
- Polycarbonate diffuser and end caps
- 4-way push terminals

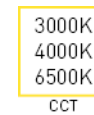
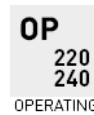
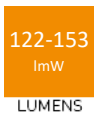

Product Code:	RSBX012-01	RSBX015-01	RSBX018-01
Comparable to:	1x/2x36W T8	1x/2x58W T8	1x/2x70W T8
Total Power (W):	19.0/18.5/19.0/36.2/34.5/36.2	24.2/23.6/24.2/51.1/48.7/51.2	34.8/33.8/34.8/67.3/63.6/67.3
Power Factor:	0.99	0.99	0.99
Total Light Output (lm):	2570/2750/2670/4410/4940/4600	3490/3730/3640/6520/7260/6820	4760/5160/4970/7950/9000/8320
Total Emergency Light Output (lm):	260	250	240
Efficacy (lm/cctW):	135/149/140/122/143/127	144/158/151/128/149/133	137/153/143/118/141/123
Lux at 1m (lux):	780/840/810/1350/1500/1390	1070/1140/1110/2000/2220/2070	1290/1390/1330/2150/2420/2330
Emergency Lux at 1m (lux):	80	80	70
CCT (K):	3000/4000/6500	3000/4000/6500	3000/4000/6500
CRI:	80	80	80
IP:	20	20	20
Operation Temperature (°C):	-20 ≤ Ta ≤ +40	-20 ≤ Ta ≤ +40	-20 ≤ Ta ≤ +40
Inrush Current:	12.9A/196us	14.5A/195us	17.5A/210us
RG Value:	0	0	0
SDCM:	6	6	6
P _{st} LM:	NA	NA	NA
SVM:	NA	NA	NA
Energy Class:	D	D	D
Rated Life to L70B50 (Hrs):	50000	50000	50000
Dimensions LxWxH (mm):	1230x66x66	1530x66x66	1830x66x66
Weight (kg):	1.29	1.55	

Separate Control Gear Information			
Type of Light Source:	LED	LED	LED
Full Load Efficiency (%):	93	94	94
P _{NET} (W):	NA	NA	NA
Dimensions (mm):	148x34x25	192x40x25	167x37x25

Product is certified to all the relevant standards.

Please contact our technical department for market specific compliances.

PLEASE NOTE: INFORMATION IN THIS DOCUMENT MAY BE SUBJECT TO CHANGE WITHOUT PRIOR NOTICE

IRE: TEL: +353 1 709 9000
 UK: TEL: 0800 973 220
 AUS: TEL: +61 7 3890 5444
 NZ: TEL: +64 03 668 5285

WEB: ROBUS.COM
 WEB: ROBUS.COM
 WEB: ROBUS.COM.AU
 WEB: ROBUSLED.CO.NZ

LED GROUP EUROPE · UK · AUSTRALIA · NEW ZEALAND · ASIA · MIDDLE EAST · AFRICA

SPEEDBEAM PLUS

18/36W, 24/48W, 34/68W, IP20

Cone Illuminance Diagram

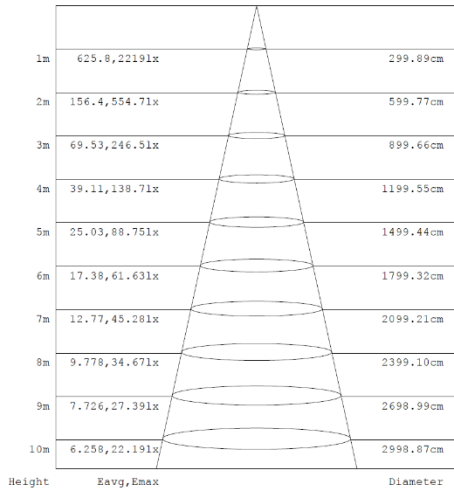
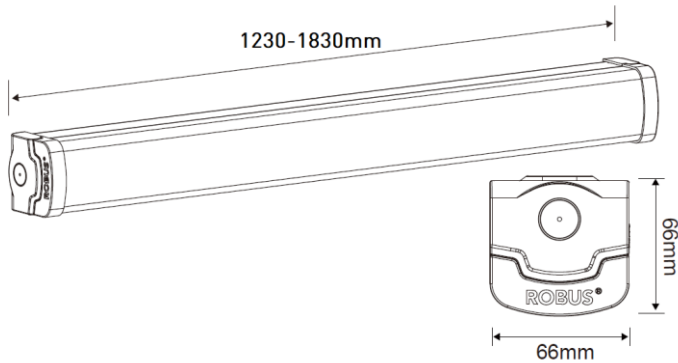

Diagram for RSBX015-01 in 52W, 4000K. Other diagrams available on request

Dimension Diagram



Sensor Data

Time Off Delay:	5s to 10min
Illuminance Switching Range:	2lux to 50lux, disabled
Sensitivity Range (%):	50%, 100%
Mounting Height (max):	5m
Detection Zone Diameter (max):	10m

Polar Intensity Diagram

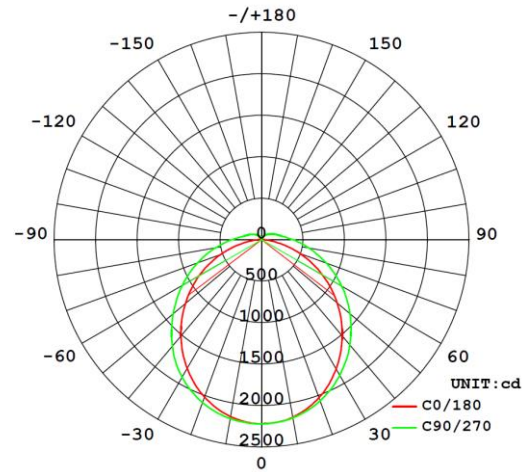

Diagram for RSBX015-01 in 52W, 4000K. Other diagrams available on request

Accessories

RLEMPKDT-PSU
RLMW

2W 3 Hour DUAL TEST Emergency Pack
Plug-in Microwave Sensor