

# ROBUS®

## SURFACE FITTING

### PORTAL LED CCT3

10W, IP54



## PRODUCT INFORMATION DOCUMENT

### FEATURES

- Available in standard, emergency, sensor, and emergency + sensor versions
- Equipped with CCT switch allowing selection between 3000K, 4000K and 6500K
- Easy wiring through the double cable entries with added silicon grommets
- 4-way, twin push-in connector block for easy loop-in/ loop-out accessible via trap door in the base of the fitting
- Slim profile of 60mm height
- Sensor versions: Dip switches located on back of fitting to control: Detection area, hold time, lux setting, stand by time and stand by dimming level

### CONSTRUCTION

- Polycarbonate base and opal diffuser
- Cold rolled steel mounting bracket
- Aluminium LED plate

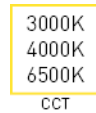
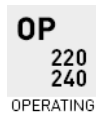
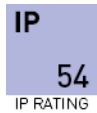
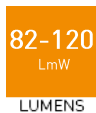

Product Code:	RP010CCT3-01	RP010CCT3S-01	RP010CCT3E-01	RP010CCT3ES-01
Comparable to:	18W PL Fluorescent	18W PL Fluorescent	18W PL Fluorescent	18W PL Fluorescent
Total Power (W):	9.1/8.9/9.1	10.7/10.5/10.7	9.7/9.4/9.7	11.1/10.9/11.1
Power Factor:	0.5	0.9	0.5	0.9
Total Light Output (lm):	980/1060/1050	890/970/960	1010/1100/1090	910/990/970
Total Emergency Light Output (lm):	NA	NA	230	230
Efficacy (lm/cctW):	108/120/116	83/92/90	105/117/113	82/91/88
Lux at 1m (lux):	270/300/300	250/270/270	280/310/300	260/280/270
Emergency Lux at 1m (lux):	NA	NA	70	70
CCT (K):	3000/4000/6500	3000/4000/6500	3000/4000/6500	3000/4000/6500
CRI:	80	80	80	80
IP:	54	54	54	54
Operation Temperature (°C):	-20 ≤ Ta ≤ +40	-20 ≤ Ta ≤ +40	0 ≤ Ta ≤ +40	0 ≤ Ta ≤ +40
Inrush Current:	3.5A/180us	11A/116us	3.5A/180us	11A/116us
RG Value:	0	0	0	0
SDCM:	<6	<6	<6	<6
P <sub>ST</sub> LM:	NA	NA	NA	NA
SVM:	NA	NA	NA	NA
Energy Class:	D	D	D	D
Rated Life to L70B50 (Hrs):	120000	120000	120000	120000
Rated Life to L80B10 (Hrs):	75000	75000	75000	75000
Rated Life to L90B10 (Hrs):	37000	37000	37000	37000
Dimensions ØxH (mm):	300x60	300x60	300x60	300x60
Weight (kg):	0.84	0.87	0.97	1.00

### Separate Control Gear Information

Type of Light Source:	LED	LED	LED	LED
Full Load Efficiency (%):	90	75	90	75
P <sub>NET</sub> (W):	NA	NA	NA	NA
Dimensions (mm):	63x36x17	77x68x20	63x36x17	77x68x20

Product is certified to all the relevant standards.

Please contact our technical department for market specific compliances.

PLEASE NOTE: INFORMATION IN THIS DOCUMENT MAY BE SUBJECT TO CHANGE WITHOUT PRIOR NOTICE

IRE: TEL: +353 1 709 9000  
 UK: TEL: 0800 973 220  
 AUS: TEL: +61 7 3890 5444  
 NZ: TEL: +64 03 668 5285

WEB: ROBUS.COM  
 WEB: ROBUS.COM  
 WEB: ROBUS.COM.AU  
 WEB: ROBUSLED.CO.NZ

LED GROUP EUROPE · UK · AUSTRALIA · NEW ZEALAND · ASIA · MIDDLE EAST · AFRICA

### PORTAL LED CCT3

10W, IP54

#### Cone Illuminance Diagram

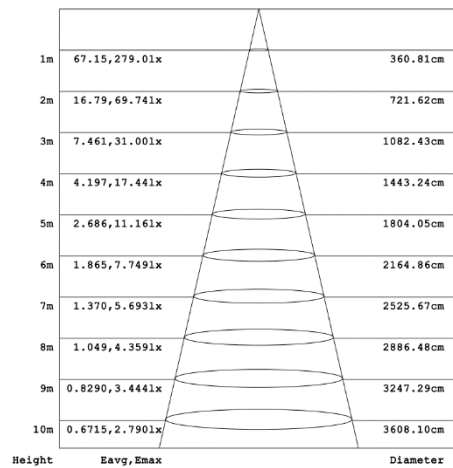
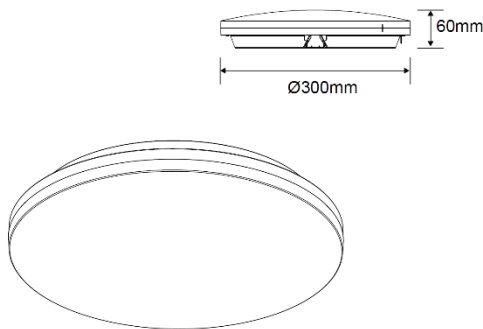

Diagram for RP010CCT3-01 in 3000K. Other diagrams available on request

#### Dimension Diagram



#### Sensor Data

Time Off Delay:	5s/ 90s/ 5min/ 10min
Illuminance Switching Range (Lux):	2lux/10lux/50lux/disabled
Sensitivity Range (%):	50%/ 100%
Stand By Dimming Levels:	20%/40%/100%
Mounting Height (max):	6m
Detection Zone Diameter (max):	14m

#### Polar Intensity Diagram

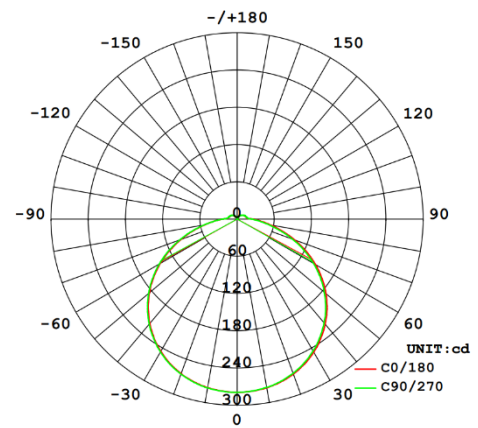

Diagram for RP010CCT3-01 in 3000K. Other diagrams available on request

#### Accessories

PLEASE NOTE: INFORMATION IN THIS DOCUMENT MAY BE SUBJECT TO CHANGE WITHOUT PRIOR NOTICE

IRE: TEL: +353 1 709 9000  
 UK: TEL: 0800 973 220  
 AUS: TEL: +61 7 3890 5444  
 NZ: TEL: +64 03 668 5285

WEB: ROB.US.COM  
 WEB: ROB.US.COM  
 WEB: ROB.US.COM.AU  
 WEB: ROB.US.LED.CO.NZ

LED GROUP EUROPE · UK · AUSTRALIA · NEW ZEALAND · ASIA · MIDDLE EAST · AFRICA