



Driver LC 10W 250mA fixC R ADV

ADV series

Product description

- Fixed output built-in LED Driver
- Constant current LED Driver
- Output current 250 mA
- For luminaires of protection class II
- For ambient temperatures up to 60 °C
- Nominal life-time up to 50,000 h (at ta 50 °C)
- 5-year guarantee

Properties

- Casing: polycarbonat, white
- Type of protection IP20

Functions

- Over voltage protection
- Short-circuit protection
- Over temperature protection
- No-load protection

Typical applications

- For track light, wall light and other pendent application



Standards, page 3

Wiring diagrams and installation examples, page 3

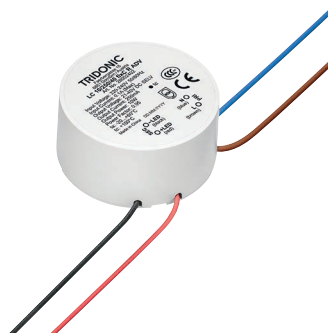

IP20 SELV                                                                  

Driver LC 10W 250mA fixC R ADV

ADV series

Technical data

Rated supply voltage	220 – 240 V
AC voltage range	198 – 264 V
Mains frequency	50 / 60 Hz
Typ. input current (at 230 V, 50 Hz, full load)	0.055 A
Leakage current (at 230 V, 50 Hz, full load)	< 700 μ A
THD (at 230 V, 50 Hz, full load)	< 9 %
Output current tolerance ^①	\pm 5 %
Typ. output LF current ripple at full load ^②	\pm 5 %
Turn on time (at 230 V, 50 Hz, full load)	\leq 0.5 s
Turn off time (at 230 V, 50 Hz, full load)	\leq 0.5 s
Ambient temperature t_a	-20 ... +60 °C
Ambient temperature t_a (at life-time 50,000 h)	50 °C
Storage temperature t_s	-20 ... +70 °C
Mains surge capability (between L – N)	1 kV
Dimensions \varnothing x H	\varnothing 42 x 20 mm

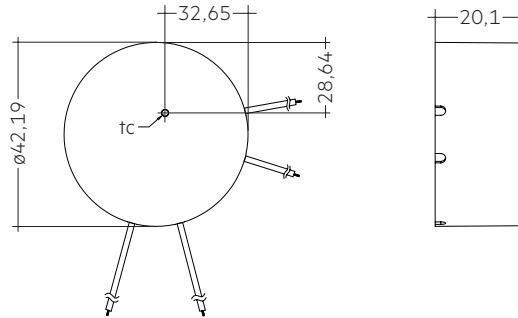

Ordering data

Type	Article number	Packaging, carton	Packaging, palett	Weight per pc.
LC 10/250/40 fixC R ADV	28002402	300 pc(s).	5,400 pc(s).	0.045 kg

Specific technical data

Type	Output current ^②	Max. input current	Typ. power consumption (at 230 V, 50 Hz, full load)	Max. input power	Output power range	λ at full load ^③	Efficiency at full load ^③	λ at min. load ^④	Efficiency at min. load ^④	Min. forward voltage	Max. forward voltage	Max. output voltage (U-OUT)	Max. peak output current at full load ^⑤	Max. casing temperature t_c
LC 10/250/40 fixC R ADV	250 mA	0.1 A	12 W	13 W	5 – 10 W	0.95	84 %	0.88C	80 %	21 V	40 V	50 V	263 mA	100 °C

^① Test result at 230 V, 50 Hz

^② Output current is mean value.

^③ The trend between min. and full load is linear and depends on load's voltage-current character.

^④ Typical value at full load, depends on load's voltage-current character.

1. Standards

EN 55015
EN 61000-3-2
EN 61000-3-3
EN 61347-1
EN 61347-2-13
EN 61547

2. Thermal details and life-time

2.1 Expected life-time

Expected life-time			
Type	ta	50 °C	60 °C
LC 10/250/40 fixC R ADV	tc	90 °C	100 °C
	Life-time	50,000 h	30,000 h

3. Installation / wiring

3.1 Circuit diagram

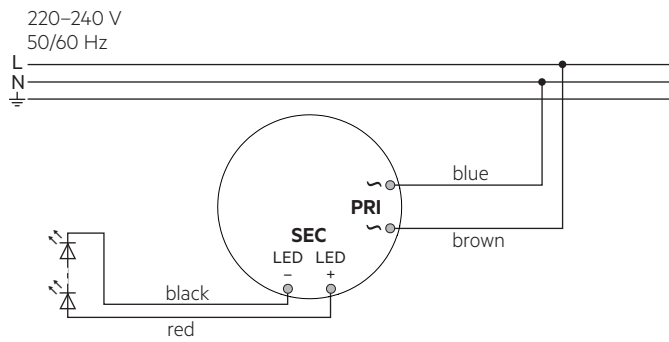

3.2 Connection

Primary cable		Secondary cable	
L	N	+	-
brown	blue	red	black

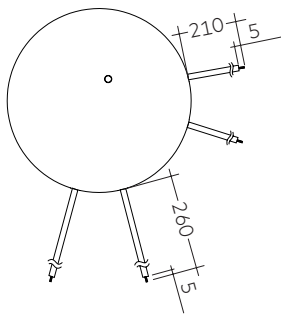

PRI:
2 x 0.75 mm²

SEC:
2 x 0.5 mm²

3.3 Wiring instructions

- All connections must be kept as short as possible to ensure good EMI behaviour
- Mains leads should be kept apart from LED Driver and other leads (ideally 5 – 10 cm distance)
- The maximum length of output wires is 3 m.
- Secondary switching is not permitted.
- Incorrect wiring can damage LED modules.
- To avoid the damage of the Driver, the wiring must be protected against short circuits to earth (sharp edged metal parts, metal cable clips, louver, etc.).

3.4 Installation instructions

The switching of LEDs on secondary side is not permitted.

4. Electrical values

4.1 Diagrams

4.1.1 Efficiency vs Load

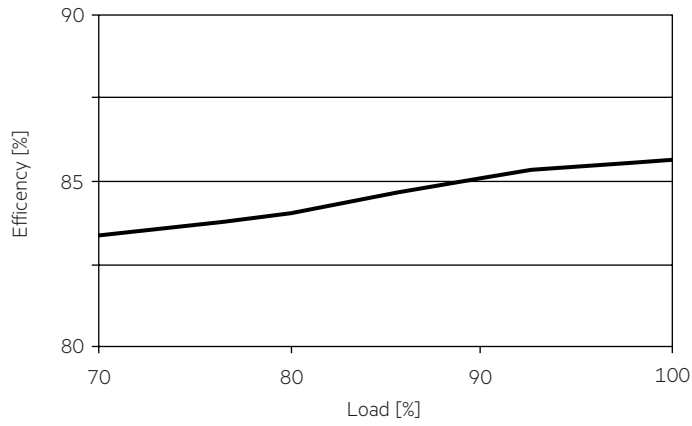

4.1.2 Power factor vs Load

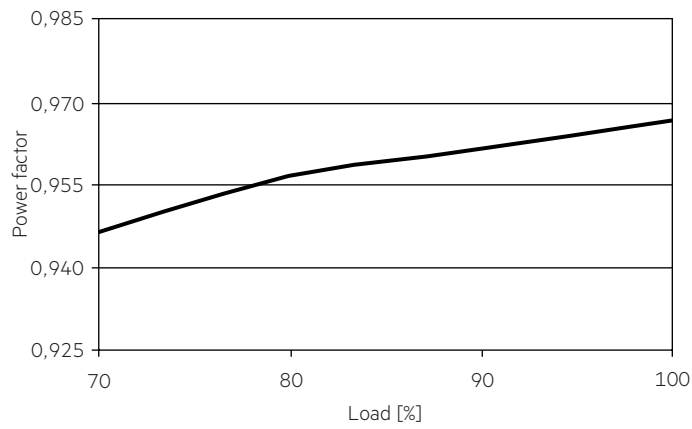

4.1.3 THD vs Load

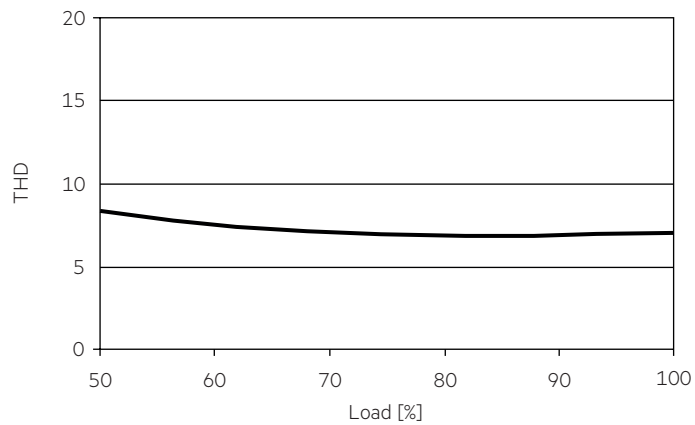

**4.2 Harmonic distortion in the mains supply (at 230 V / 50 Hz and full load)
in %**

	THD	3.	5.	7.	9.	11.
LC 10/250/40 fixC R ADV	< 9	< 4	< 4	< 3	< 1	< 2

Acc. to 6100-3-2. Harmonics < 5 mA or < 0.6 % (whatever is greater) of the input current are not considered for calculation of THD.

5. Functions

5.1 Over voltage protection

If the output voltage is over (1.1 – 1.25 V) V_{out} , the LED Driver will shut down and enter its protection status, the Driver will reset and work normally if the fault condition was eliminated.

5.2 Short-circuit behaviour

In case of a short circuit on the secondary side (LED) the LED Driver switched off. After elimination of the short-circuit fault the LED Driver will recover automatically.

5.3 Over temperature protection

The LED Driver will reduce the LED output current.
When temperature is up to 145 °C (typical) the output current of the system will be reduced according to the sensed temperature. The output current will be reduce to about half of the setting value at 165 °C (typical).
When temperature rises above 170 °C (typical), the device will stop working.

5.4 No-load protection

The LED Driver will shut down and enter its protection status, the Driver will reset and work normally if the fault condition was eliminated.

6. Miscellaneous

6.1 Isolation and electric strength testing of luminaires

Electronic devices can be damaged by high voltage. This has to be considered during the routine testing of the luminaires in production.

According to IEC 60598-1 Annex Q (informative only!) or ENEC 303-Annex A, each luminaire should be submitted to an isolation test with 500 V_{DC} for 1 second. This test voltage should be connected between the interconnected phase and neutral terminals and the earth terminal.
The isolation resistance must be at least 2 MΩ.

As an alternative, IEC 60598-1 Annex Q describes a test of the electrical strength with 1500 V_{AC} (or 1.414 x 1500 V_{DC}). To avoid damage to the electronic devices this test must not be conducted.

6.2 Conditions of use and storage

Humidity: 10 % up to max. 90 %,
not condensed
(max. 56 days/year at 95 %)

Storage temperature: -20 °C up to max. +70 °C

The devices have to be within the specified temperature range (ta) before they can be operated.

6.3 Additional information

Additional technical information at www.tridonic.com → Technical Data

Guarantee conditions at www.tridonic.com → Services

Life-time declarations are informative and represent no warranty claim.
No warranty if device was opened.