

IP20 SELV  

Driver LCBI 15 W 350/500/700 mA basic PHASE-CUT SR ADV basic series

Product description

- Dimmable via leading-edge and trailing-edge phase dimmer
- Nominal life of 60,000 h (at t_a max. 50 °C with a failure rate of max. 0.2 % per 1,000 h)
- 350, 500 or 700 mA output current
- Screw terminals
- Connecting cable, wire cross-section 0.5 – 2.5 mm²
- Output power 14/15 W
- SELV
- Type of protection IP20
- Output dimmed analogue (current amplitude)
- Dimming range typ. 5 to 100 % (depending on dimmer)
- Potted version

Properties

- Casing: polycarbonat, white
- Compact dimensions
- Overload protection
- Short-circuit protection

Technical data

Rated supply voltage	220 – 240 V
AC voltage range	198 – 264 V
Mains frequency	50 / 60 Hz
Typ. rated current (at 230 V, 50 Hz, full load)	0.09 A
λ at full load [®]	0.99
λ at min. load [®]	0.95
Output current tolerance at full load ^{®®®}	± 7.5 %
Typ. current ripple (at 230 V, 50 Hz, full load)	± 30 %
Starting time (at 230 V, 50 Hz, full load)	≤ 0.1 s
Turn off time (at 230 V, 50 Hz, full load)	≤ 0.1 s
Hold on time at power failure (output)	0 s
Ambient temperature t_a	-25 ... +50 °C
Ambient temperature t_a (at life-time 60,000 h)	50 °C
Max. casing temperature t_c	75 °C
Storage temperature t_s	-40 ... +85 °C
Dimensions L x W x H	102 x 51 x 30 mm

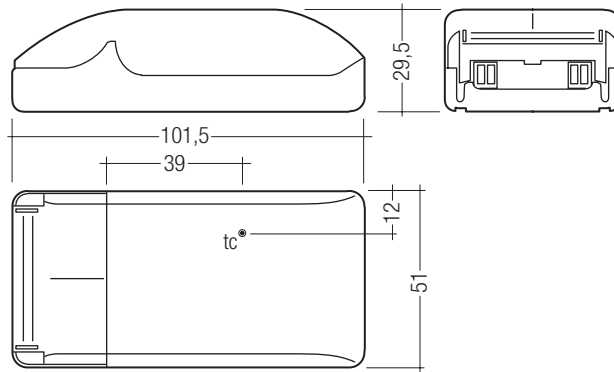

Ordering data

Type	Article number	Packaging			Weight per pc.
		carton	low volume	high volume	
LCBI 15W 350mA basic PHASE-CUT SR ADV	87500386	20 pc(s).	440 pc(s).	2,200 pc(s).	0.170 kg
LCBI 15W 500mA basic PHASE-CUT SR ADV	87500320	20 pc(s).	440 pc(s).	2,200 pc(s).	0.167 kg
LCBI 14W 700mA basic PHASE-CUT SR ADV	87500387	20 pc(s).	440 pc(s).	2,200 pc(s).	0.170 kg



Standards, page 3

Wiring diagrams and installation examples, page 3

Specific technical data

Type	Efficiency at full load ^①	Efficiency at min. load ^①	Output current ^②	Max. peak output current at full load ^{③④}	Max. peak output current at min. load ^{③④}	Max. forward voltage ^⑤	Min. forward voltage ^⑤	Max. output voltage ^⑥	Max. input power	Max. output power
LCBI 15W 350mA basic PHASE-CUT SR ADV	78 %	76 %	350 mA	540 mA	760 mA	42 V	21.0 V	55 V	19 W	15 W
LCBI 15W 500mA basic PHASE-CUT SR ADV	77 %	75 %	500 mA	780 mA	1,030 mA	30 V	13.5 V	34 V	20 W	15 W
LCBI 14W 700mA basic PHASE-CUT SR ADV	76 %	74 %	700 mA	1,240 mA	1,580 mA	20 V	10.0 V	26 V	19 W	14 W

^① Test result at 230 V, 50 Hz.

^② The trend between min. and full load is linear.

^③ Output current tolerance at full load is max. 10 % and the tolerance for min. load is depend on the typical rated current.

^④ At failure mode.

^⑤ Output current is mean value.

Standards

EN 55015
EN 61000-3-2
EN 61000-3-3
EN 61347-1
EN 61347-2-13
EN 61547
EN 62384

Glow wire test

according to EN 60598-1 with increased temperature of 850 °C passed.

Overload protection

If the output voltage range is exceeded the LED Driver reduces the LED output current. After elimination of the overload the nominal operation is restored automatically.

Short-circuit behaviour

In case of a short circuit on the secondary side (LED) the LED Driver switches into hic-cup mode. After the removal of the short-circuit fault the LED Driver will recover automatically.

No-load operation

The LED Driver works in constant current mode. In no-load operation there is the max. output voltage at the output (see page 1).

Installation instructions

Note the requirements set out in the document LED_driver_installation_advise.pdf (<http://www.tridonic.com/com/en/technical-docs.asp>).

Hot plug-in or secondary switching of LEDs is not permitted and may cause a very high current to the LEDs.

Expected life-time

Type	ta	40 °C	45 °C	50 °C	60 °C
LCBI 15W 350mA basic PHASE-CUT SR ADV	tc	75 °C	80 °C	85 °C	x
	Life-time	100,000 h	70,000 h	50,000 h	x
LCBI 15W 500mA basic PHASE-CUT SR ADV	tc	75 °C	80 °C	85 °C	x
	Life-time	100,000 h	70,000 h	50,000 h	x
LCBI 14W 700mA basic PHASE-CUT SR ADV	tc	75 °C	80 °C	85 °C	x
	Life-time	100,000 h	70,000 h	50,000 h	x

Maximum loading of automatic circuit breakers

Automatic circuit breaker type									Inrush current	
	C10	C13	C16	C20	B10	B13	B16	B20	I _{max}	Time
Installation Ø	1.5 mm ²	1.5 mm ²	1.5 mm ²	2.5 mm ²	1.5 mm ²	1.5 mm ²	1.5 mm ²	2.5 mm ²		
LCBI 15W 350mA basic PHASE-CUT SR ADV	50	65	80	100	50	65	80	100	1.7 A	40 µs
LCBI 15W 500mA basic PHASE-CUT SR ADV	50	65	80	100	50	65	80	100	1.7 A	40 µs
LCBI 14W 700mA basic PHASE-CUT SR ADV	50	65	80	100	50	65	80	100	1.7 A	40 µs

Wiring diagram

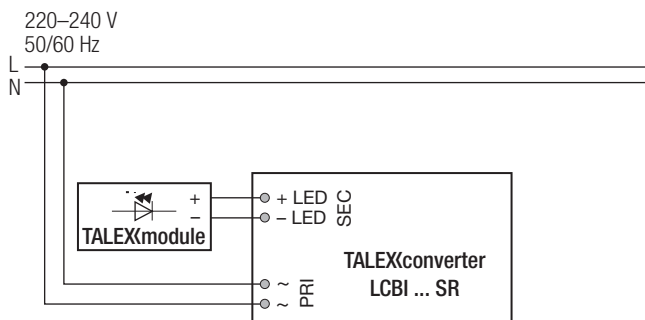

Wiring type and cross section

The wiring can be in stranded wires with ferrules or solid. For perfect function of the cage clamp terminals the strip length should be 4 – 5 mm for the input terminal.

The max. torque at the clamping screw (M3) is 0.2 Nm.

Input terminal (D2)

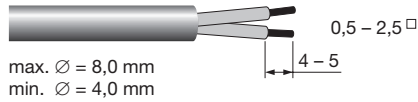

Output terminal (D1)

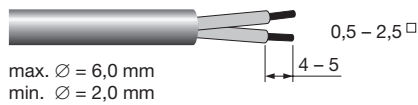

To get a proper working strain relief it is recommended that the cable jacket diameter of the side D2 is compared to the side D1 terminal according to the value table. (This can vary if the used cable jacket material varies from side D2 to D1 in pinching property).

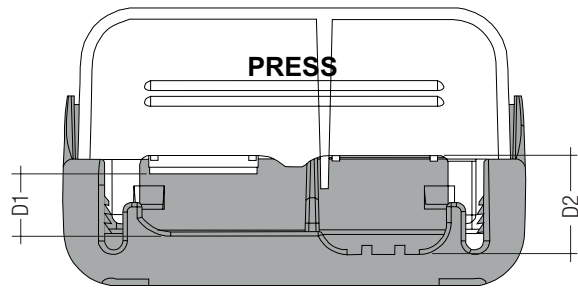

Depending on the used flaps of the terminal following cable jacket diameter difference between the side D2 and D1 terminals is recommended:

Side D1		Side D2		Difference D2 - D1
With flap	Without flap	With flap	Without flap	
x	-	-	x	4 mm
-	x	-	x	2 mm
x	-	x	-	2 mm
-	x	x	-	0 mm

Wiring instructions

The secondary leads should be separated from the mains connections and wiring for good EMC performance.
Maximum lead length on secondary side is 2 m. For a good EMC performance keep the the LED wiring as short as possible.
The secondary wires (LED module) should be routed in parallel to ensure good EMC performance.
Through wiring is not possible.

To avoid the damage of the Driver, the wiring must be protected against short circuits to earth (sharp edged metal parts, metal cable clips, louver, etc.).

Isolation and electric strength testing of luminaires

Electronic devices can be damaged by high voltage. This has to be considered during the routine testing of the luminaires in production.

According to IEC 60598-1 Annex Q (informative only!) or ENEC 303-Annex A, each luminaire should be submitted to an isolation test with 500V_{DC} for 1 second. This test voltage should be connected between the interconnected phase and neutral terminals and the earth terminal.
The isolation resistance must be at least 2 MΩ.

As an alternative, IEC 60598-1 Annex Q describes a test of the electrical strength with 1500V_{AC} (Or 1.414 x 1500V_{DC}). To avoid damage to the electronic devices this test must not be conducted.

Additional information

Additional technical information at www.tridonic.com → Technical Data

Guarantee conditions at www.tridonic.com → Services

Life-time declarations are informative and represent no warranty claim. No warranty if device was opened.

Diagrams LCBI 15W 350mA basic SR ADV

Efficiency vs load

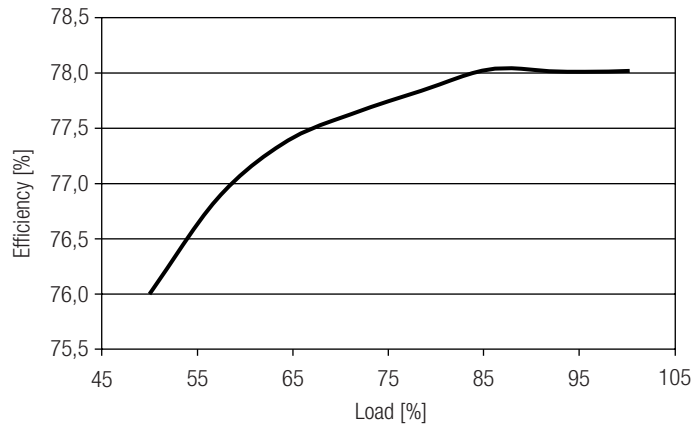

Power factor vs load

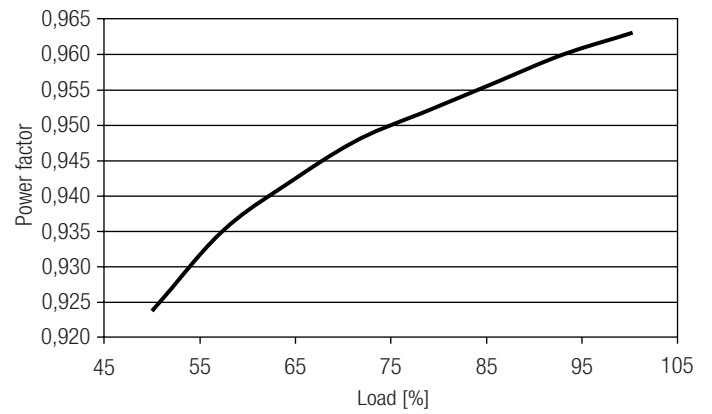

Input power vs load

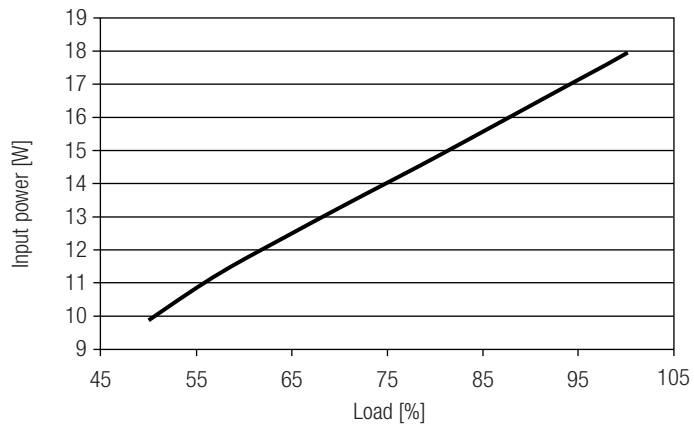

Input current vs load

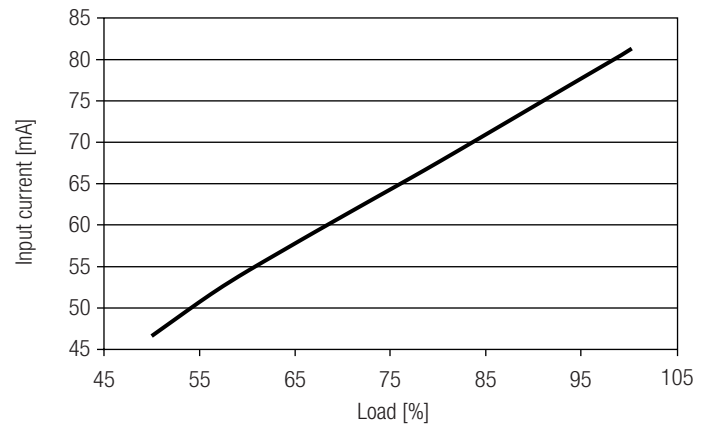

THD vs load

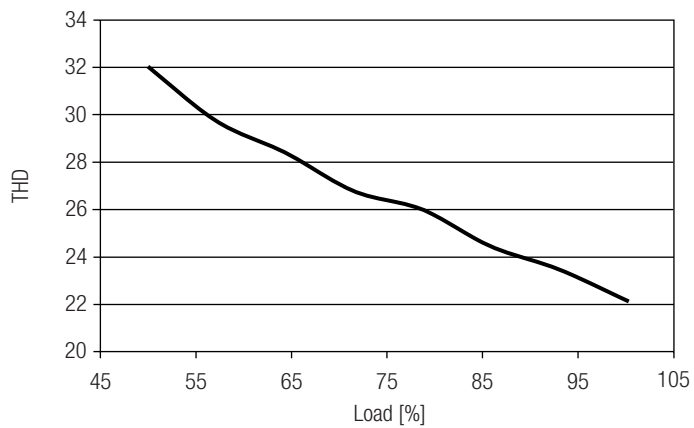

Diagrams LCBI 15W 500mA basic SR ADV

Efficiency vs load

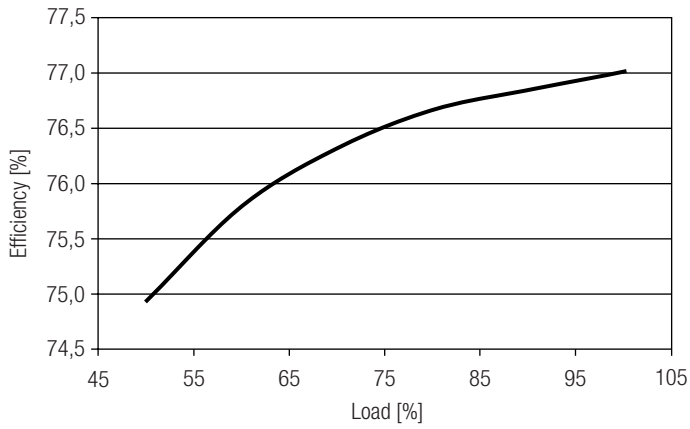

Power factor vs load

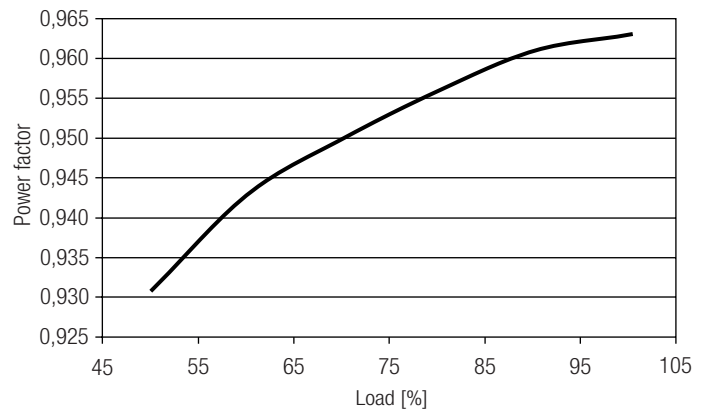

Input power vs load

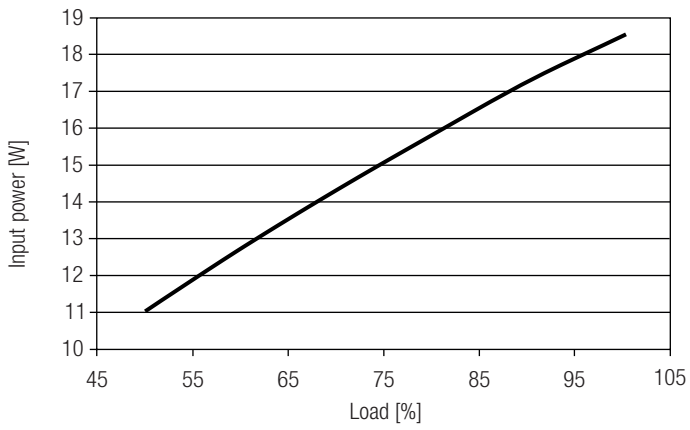

Input current vs load

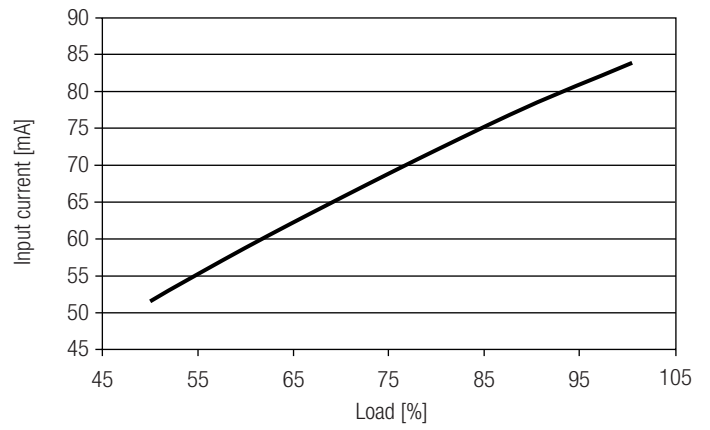

THD vs load

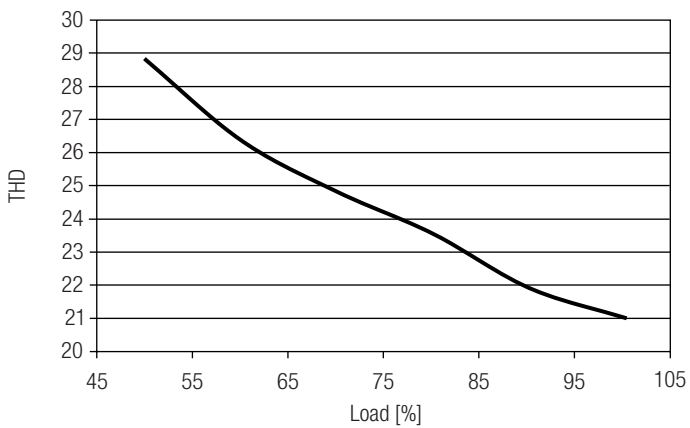

Diagrams LCBI 14W 700mA basic SR ADV

Efficiency vs load

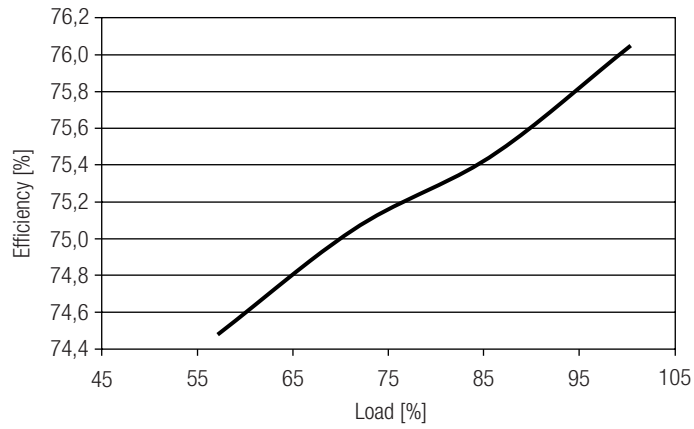

Power factor vs load

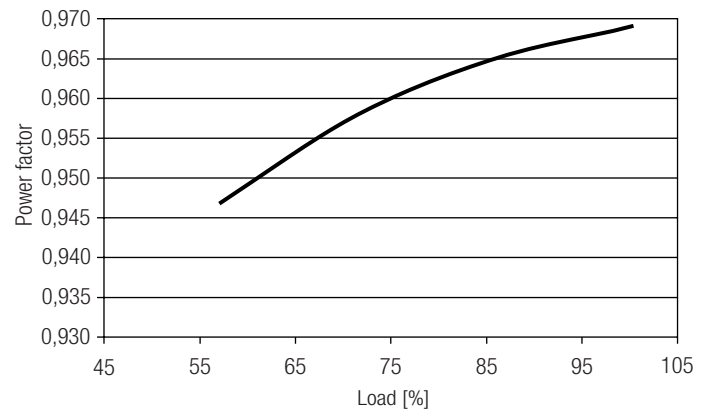

Input power vs load

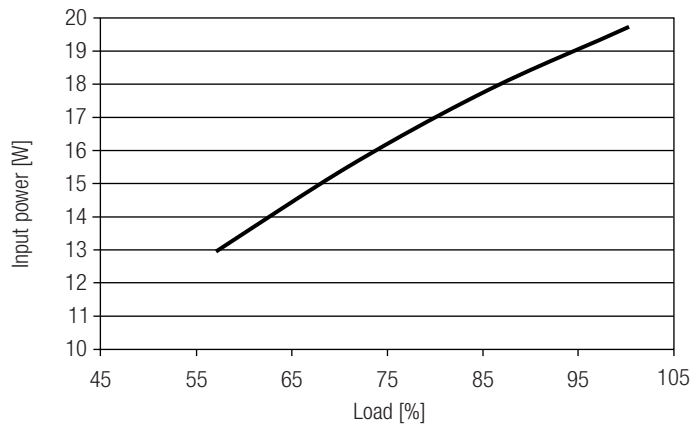

Input current vs load

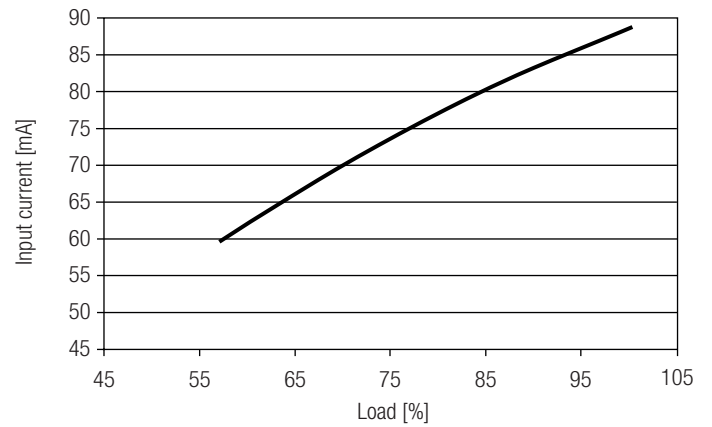

THD vs load

