



Driver LC 25W 350/500/600/700mA fixC SR SNC2 essence series

Product description

- Independent LED Driver with cable clamps
- Max. output power 25 W
- Output current 350, 500, 600 or 700 mA
- Temperature protection as per EN 61347-2-13 C5e
- Nominal life-time up to 50,000 h
- 5-year guarantee

Properties

- Casing: polycarbonat, white
- Type of protection IP20
- Push-in terminals
- 2 separate strain relief parts for input and output cables with highly robust clamps

Functions

- Overload protection
- Short-circuit protection
- No-load protection
- No output current overshoot at mains on/off
- Burst protection voltage 1 kV
- Surge protection voltage 1 kV (L to N)
- Surge protection voltage 2 kV (L/N to earth)

Typical applications

- For spot light and downlight in retail and hospitality application
- For panel light and area light in office and education application



Standards, page 3

Wiring diagrams and installation examples, page 3

IP20 SELV          RoHS

Driver LC 25W 350/500/600/700mA fixC SR SNC2

essence series

Technical data

Rated supply voltage	220 – 240 V
AC voltage range	198 – 264 V
Leakage current (at 230 V, 50 Hz, full load)	< 450 µA
Mains frequency	50/60 Hz
Overvoltage protection	320 V AC, 1 h
THD (at 230 V, 50 Hz, full load)	≤ 20 %
THD (at 230 V, 50 Hz, min. load)	≤ 20 %
Output current tolerance [®]	± 7.5 %
Typ. output LF current ripple at full load [®]	± 25 %
Starting time (at 230 V, 50 Hz, full load)	≤ 0.5 s
Turn off time (at 230 V, 50 Hz, full load)	≤ 0.5 s
Hold on time at power failure	0 s
Ambient temperature ta	-20 ... +50 °C
Ambient temperature ta (at life-time 50,000 h)	40 °C
Storage temperature ts	-40 ... +80 °C
Dimensions L x W x H	127 x 43 x 30 mm

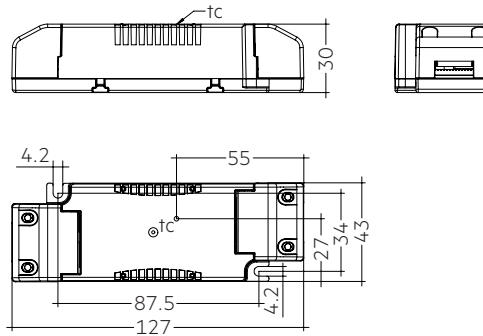

Ordering data

Type	Article number	Packaging, carton	Packaging, low volume	Packaging, high volume	Weight per pc.
LC 25/350/71 fixC SR SNC2	87500750	14 pc(s).	364 pc(s).	2,548 pc(s).	0.095 kg
LC 25/500/43 fixC SR SNC2	87500751	14 pc(s).	364 pc(s).	2,548 pc(s).	0.096 kg
LC 25/600/42 fixC SR SNC2	87500752	14 pc(s).	364 pc(s).	2,548 pc(s).	0.096 kg
LC 25/700/36 fixC SR SNC2	87500753	14 pc(s).	364 pc(s).	2,548 pc(s).	0.096 kg

Specific technical data

Type	Output current [®]	Typ. rated current (at 230 V, 50 Hz, full load)	Max. input power	Typ. power consumption (at 230 V, 50 Hz, full load)	Output power	λ at full load [®]	Efficiency at full load [®]	λ at min. load [®]	Efficiency at min. load [®]	Min. forward voltage [®]	Max. forward voltage [®]	Max. output voltage	Max. peak output current at full load [®]	Max. peak output current at min. load [®]	Max. casing temperature tc
LC 25/350/71 fixC SR SNC2	350 mA	0.130 A	28 W	27.0 W	15.8 – 24.9 W	0.93C	89 %	0.88C	88 %	45 V	71 V	100 V	490 mA	560 mA	70 °C
LC 25/500/43 fixC SR SNC2	500 mA	0.120 A	25 W	24.0 W	13.5 – 21.5 W	0.90C	90 %	0.87C	88 %	27 V	43 V	60 V	700 mA	800 mA	65 °C
LC 25/600/42 fixC SR SNC2	600 mA	0.135 A	29 W	27.5 W	16.2 – 25.2 W	0.93C	90 %	0.88C	88 %	27 V	42 V	60 V	840 mA	970 mA	70 °C
LC 25/700/36 fixC SR SNC2	700 mA	0.135 A	29 W	27.5 W	16.1 – 25.2 W	0.93C	90 %	0.88C	88 %	22 V	36 V	50 V	980 mA	1,130 mA	70 °C

[®] Test result at 230 V, 50 Hz

[®] Output current is mean value.

[®] Typical value at full load, depends on load's voltage-current character.

[®] The trend between min. and full load is linear and depends on load's voltage-current character.

1. Standards

EN 55015
EN 61000-3-2
EN 61000-3-3
EN 61347-1
EN 61347-2-13
EN 61547
EN 60598-1
EN 62384

1.1 Glow wire test

according to EN 60598-1 with increased temperature of 850 °C passed.

2. Thermal details and life-time

2.1 Expected life-time

Expected life-time			
Type	ta	40 °C	50 °C
LC 25/350/71 fixC SR SNC2	tc	60 °C [Ⓟ]	70 °C [Ⓟ]
	Life-time	50,000 h	30,000 h
LC 25/500/43 fixC SR SNC2	tc	55 °C [Ⓟ]	65 °C [Ⓟ]
	Life-time	50,000 h	30,000 h
LC 25/600/42 fixC SR SNC2	tc	60 °C [Ⓟ]	70 °C [Ⓟ]
	Life-time	50,000 h	30,000 h
LC 25/700/36 fixC SR SNC2	tc	60 °C [Ⓟ]	70 °C [Ⓟ]
	Life-time	50,000 h	30,000 h

[Ⓟ] Test result at max. output voltage.

The LED Drivers are designed for a life-time stated above under reference conditions and with a failure probability of less than 10 %. Life-time declarations are informative and represent no warranty claim.

3. Installation / wiring

3.1 Circuit diagram

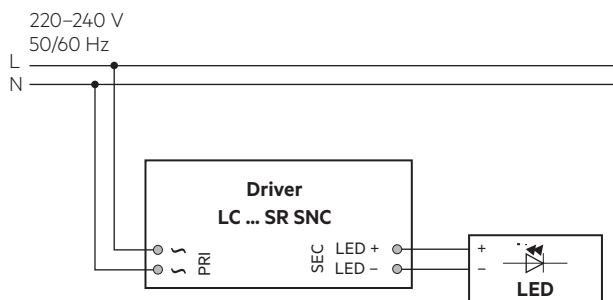

3.2 Wiring type and cross section

The wiring can be in stranded wires with ferrules or solid with a cross section of 0.5–1.5 mm². Strip 8.5–9.5 mm of insulation from the cables to ensure perfect operation of the push-wire terminals. Use one wire for each terminal connector only. The max. torque at the clamping screw (M4) is 0.3 Nm.

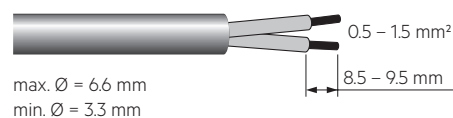

The following cable types are approved and recommended by Tridonic:

RVVB 2 x 0.5 mm²
RVVB 2 x 0.75 mm²
RVVB 2 x 1 mm²
RVVB 2 x 1.5 mm²
RVV 3 x 0.75 mm²
SOLID 2.5 mm²

3.3 Release of the wiring

Press down the “push button” and remove the cable from front.

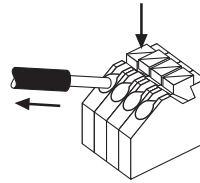

3.4 Fixing conditions

Dry, acidfree, oilfree, fatfree. It is not allowed to exceed the maximum ambient temperature (ta) stated on the device. Minimum distances stated below are recommendations and depend on the actual luminaire. Is not suitable for fixing in corner.

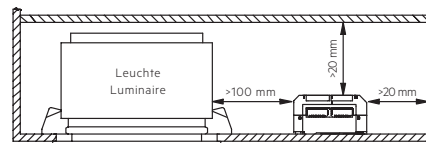

3.5 Wiring guidelines

- All connections must be kept as short as possible to ensure good EMI behaviour.
- Mains leads should be kept apart from LED Driver and other leads (ideally 5 – 10 cm distance)
- Max. length of output wires is 2 m.
- The secondary wires (LED module) should be routed in parallel to ensure good EMC performance.
- Secondary switching is not permitted.
- Incorrect wiring can damage LED modules.
- To avoid the damage of the Driver, the wiring must be protected against short circuits to earth (sharp edged metal parts, metal cable clips, louver, etc.).

3.6 Replace LED module

1. Mains off
2. Remove LED module
3. Wait for 20 seconds
4. Connect LED module again

Hot plug-in or secondary switching of LEDs is not permitted and may cause a very high current to the LEDs.

3.7 Installation instructions

The LED module and all contact points within the wiring must be sufficiently insulated against 3 kV surge voltage. Air and creepage distance must be maintained.

3.8 Mounting of device

Max. torque for fixing: 0.5 Nm/M4

4. Electrical values

4.1 Diagrams LC 25W 350mA fixC SR SNC2

4.1.1 Efficiency vs load

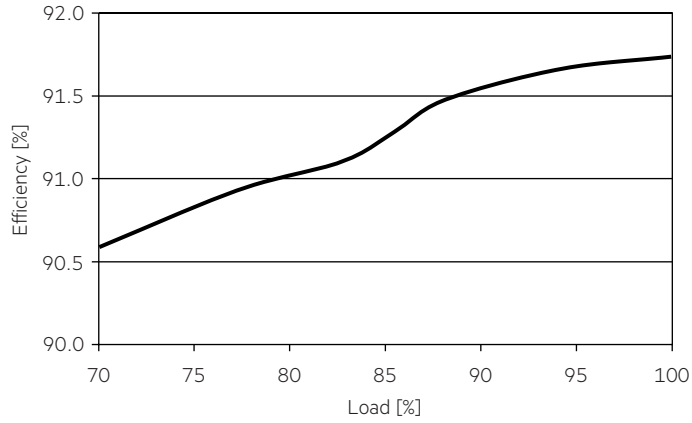

4.1.4 Input current vs load

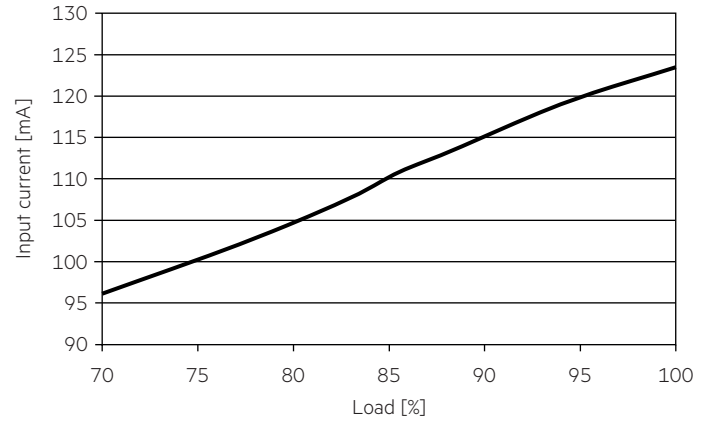

4.1.2 Power factor vs load

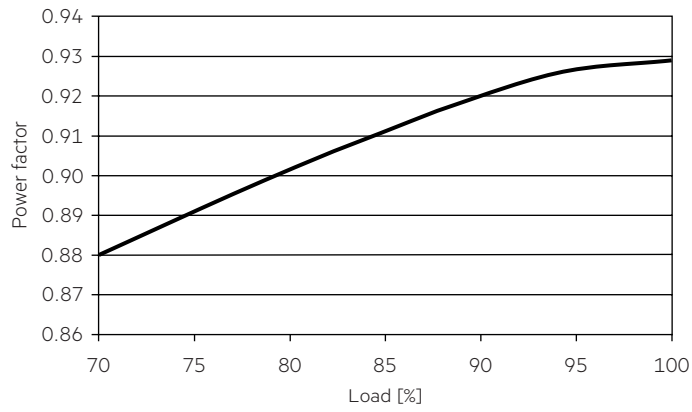

4.1.5 THD vs load

THD without harmonic < 5 mA (0.6 %) of the input current:

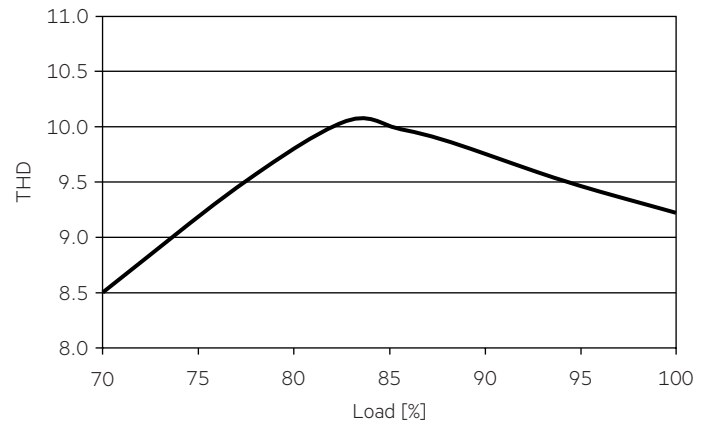

4.1.3 Input power vs load

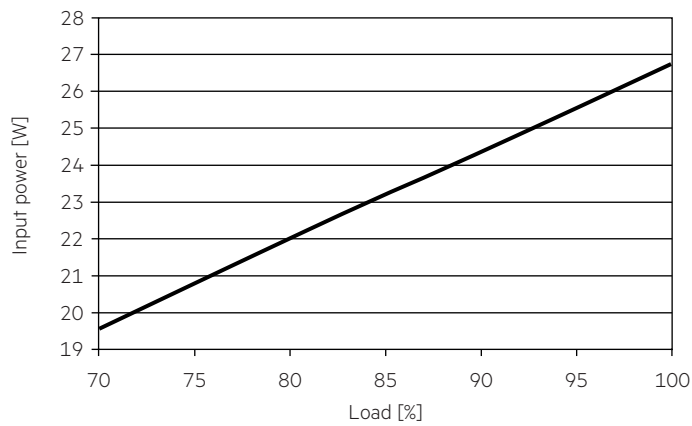

4.2 Diagrams LC 25W 500mA fixC SR SNC2

4.2.1 Efficiency vs load

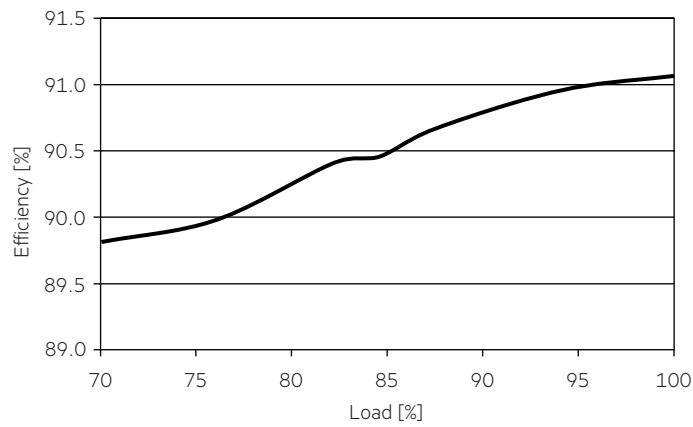

4.2.4 Input current vs load

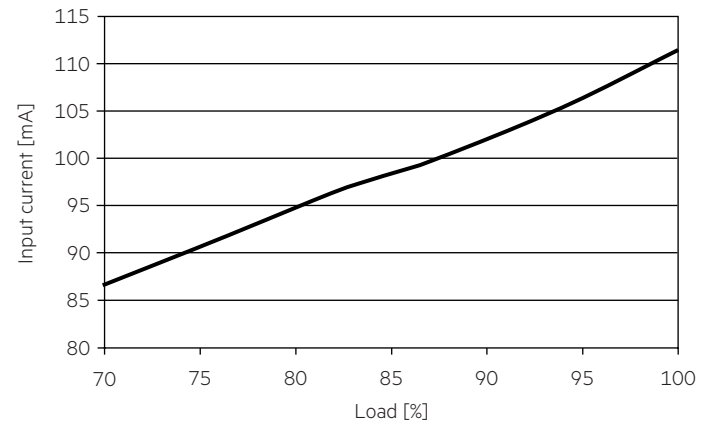

4.2.2 Power factor vs load

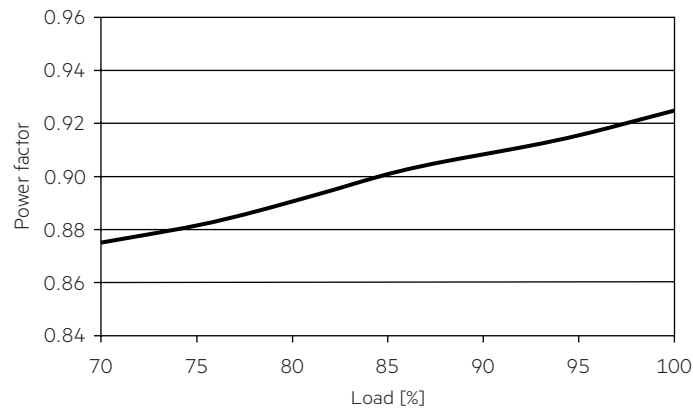

4.2.5 THD vs load

THD without harmonic < 5 mA (0.6 %) of the input current:

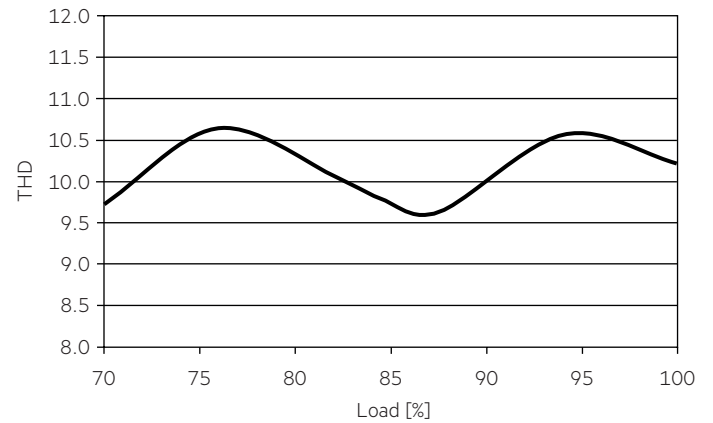

4.2.3 Input power vs load

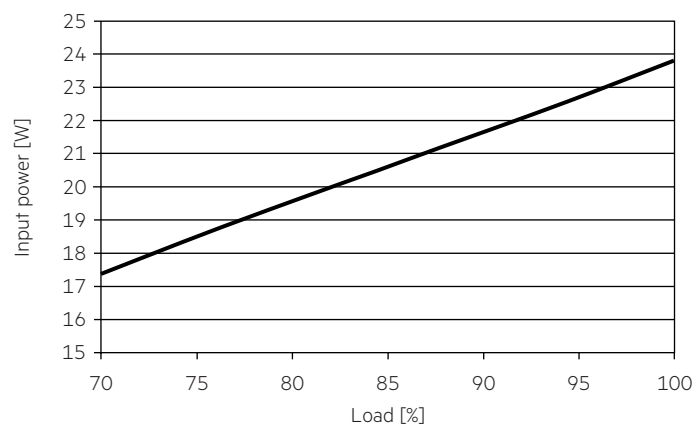

4.3 Diagrams LC 25W 600mA fixC SR SNC2

4.3.1 Efficiency vs load

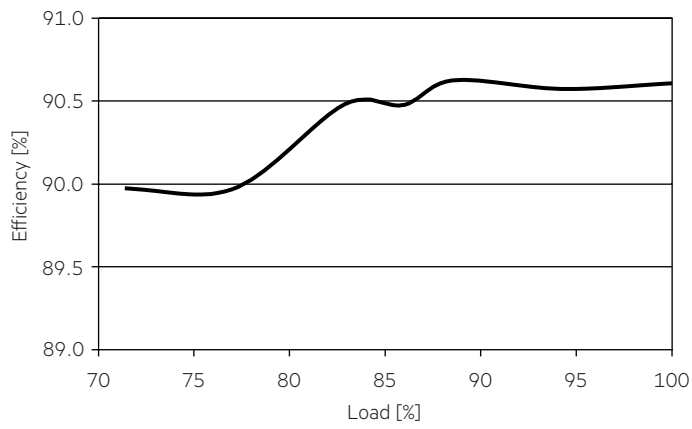

4.3.4 Input current vs load

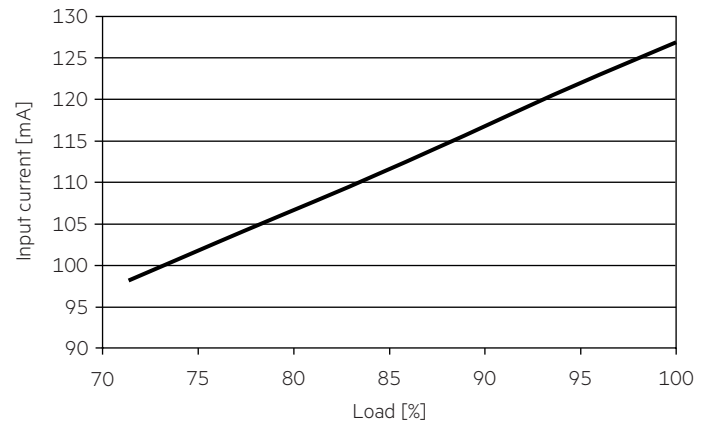

4.3.2 Power factor vs load

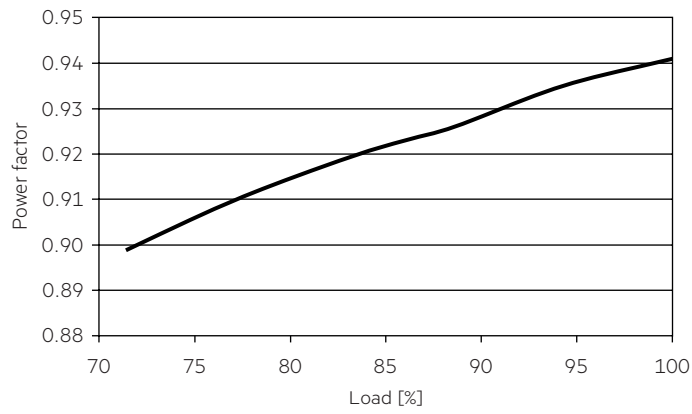

4.3.5 THD vs load

THD without harmonic < 5 mA (0.6 %) of the input current:

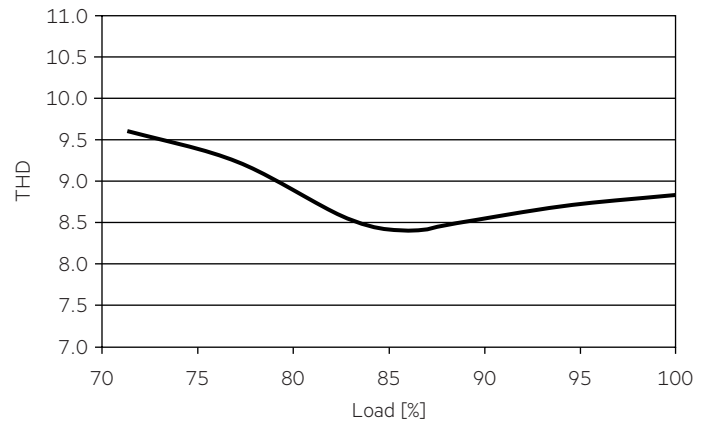

4.3.3 Input power vs load

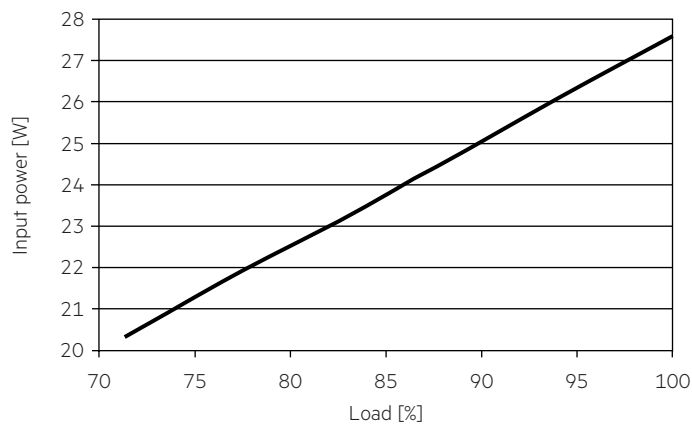

4.4 Diagrams LC 25W 700mA fixC SR SNC2

4.4.1 Efficiency vs load

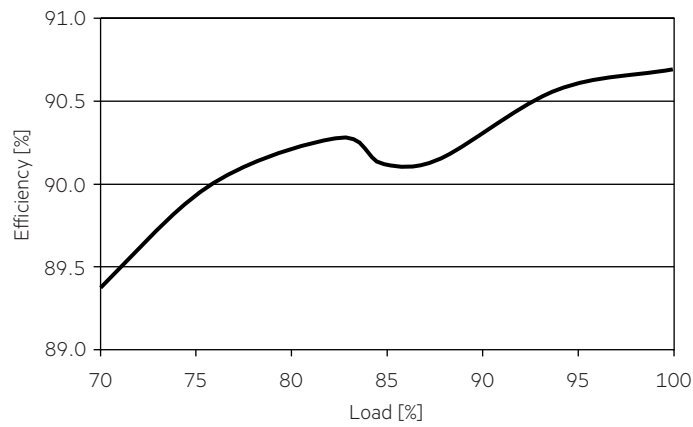

4.4.4 Input current vs load

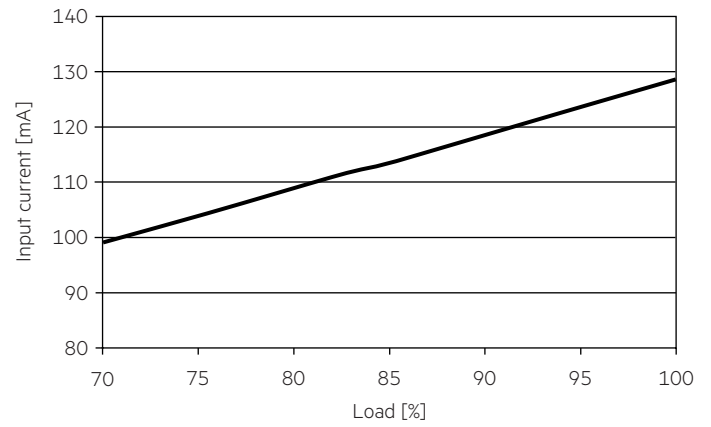

4.4.2 Power factor vs load

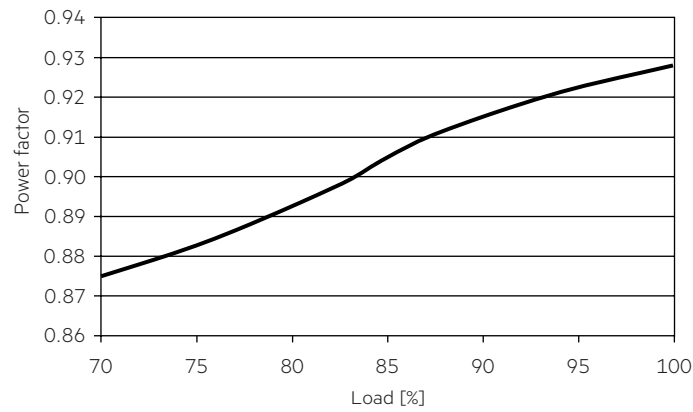

4.4.5 THD vs load

THD without harmonic < 5 mA (0.6 %) of the input current:

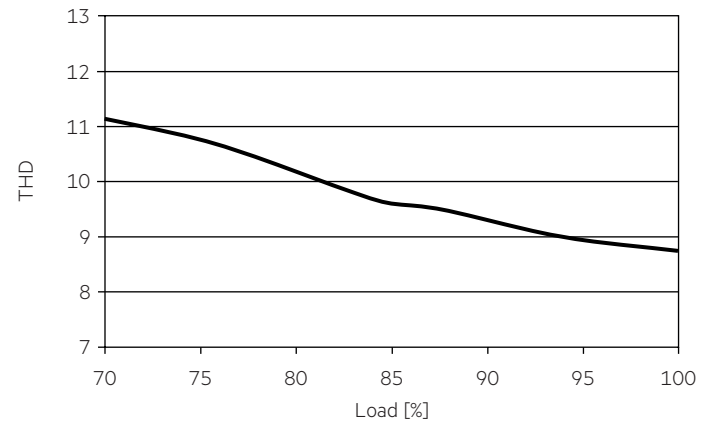

4.4.3 Input power vs load

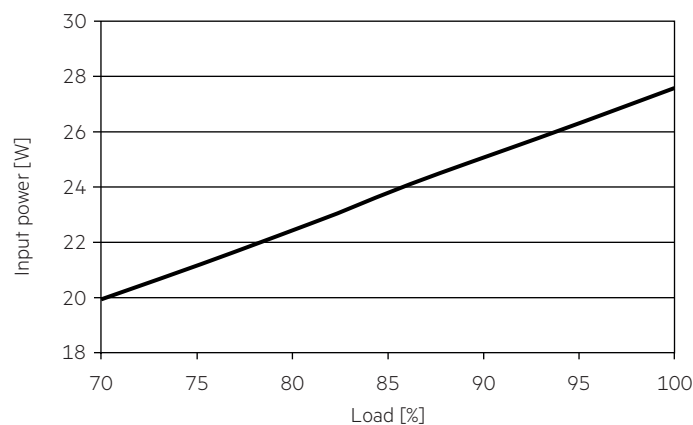

4.3 Maximum loading of automatic circuit breakers

Automatic circuit breaker type	C10	C13	C16	C20	B10	B13	B16	B20	Inrush current
Installation Ø	1.5 mm ²	1.5 mm ²	1.5 mm ²	2.5 mm ²	1.5 mm ²	1.5 mm ²	1.5 mm ²	2.5 mm ²	I _{max} Time
LC 25/350/71 fixC SR SNC2	65	80	100	125	55	70	90	110	8 A 80 µs
LC 25/500/43 fixC SR SNC2	65	80	100	125	55	70	90	110	8 A 80 µs
LC 25/600/42 fixC SR SNC2	65	80	100	125	55	70	90	110	8 A 80 µs
LC 25/700/36 fixC SR SNC2	65	80	100	125	55	70	90	110	8 A 80 µs

4.4 Harmonic distortion in the mains supply (at 230 V / 50 Hz and full load) in %

	THD	3.	5.	7.	9.	11.
LC 25/350/71 fixC SR SNC2	< 20	< 10	< 7	< 6	< 5	< 3
LC 25/500/43 fixC SR SNC2	< 20	< 10	< 8	< 7	< 5	< 3
LC 25/600/42 fixC SR SNC2	< 20	< 11	< 7	< 6	< 5	< 3
LC 25/700/36 fixC SR SNC2	< 20	< 11	< 7	< 6	< 5	< 3

Acc. to 6100-3-2. Harmonics < 5 mA or < 0.6 % (whatever is greater) of the input current are not considered for calculation of THD.

5. Functions

5.1 Short-circuit behaviour

In case of a short circuit on the secondary side (LED) the LED Driver switches into hic-cup mode. After elimination of the short-circuit fault the LED Driver will recover automatically.

5.2 No-load operation

The LED Driver works in burst working mode to provide a constant output voltage regulation which allows the application to be able to work safely when LED string opens due to a failure.

5.3 Overload protection

If the output voltage range is exceeded the LED Driver will protect itself and LED may flicker. After elimination of the overload, the nominal operation is restored automatically.

6. Miscellaneous

6.1 Isolation and electric strength testing of luminaires

Electronic devices can be damaged by high voltage. This has to be considered during the routine testing of the luminaires in production.

According to IEC 60598-1 Annex Q (informative only!) or ENEC 303-Annex A, each luminaire should be submitted to an isolation test with 500 V_{DC} for 1 second. This test voltage should be connected between the interconnected phase and neutral terminals and the earth terminal. The isolation resistance must be at least 2 MΩ.

As an alternative, IEC 60598-1 Annex Q describes a test of the electrical strength with 1500 V_{AC} (or 1.414 x 1500 V_{DC}). To avoid damage to the electronic devices this test must not be conducted.

6.2 Conditions of use and storage

Humidity: 5 % up to max. 85 %, not condensed (max. 56 days/year at 85 %)

Storage temperature: -40 °C up to max. +80 °C

The devices have to be within the specified temperature range (t_a) before they can be operated.

6.3 Additional information

Additional technical information at www.tridonic.com → Technical Data

Guarantee conditions at www.tridonic.com → Services

Life-time declarations are informative and represent no warranty claim. No warranty if device was opened.