

Electronic ballasts for dimming to 1 %  
Linear lamps T5, 16 mm high efficiency

PCA T5 EXCEL one4all 14–35 W 220–240 V 50/60/0 Hz, dimmable

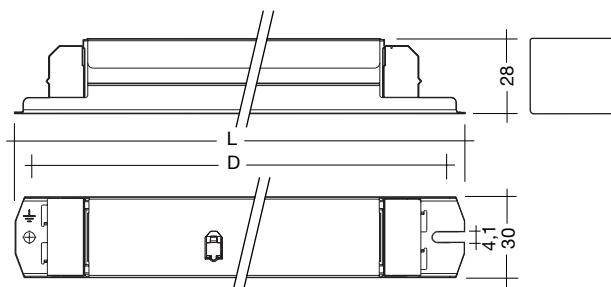

- dimming range from 1–100 %
- lamp start at 1 % possible
- lamp friendly warm start within 1.5 s with AC and 0.6 s with DC
- switch via the mains or with digital control signal
- dimming which is comfortable to the eye
- disturbance free precise control with a digital signal (**DSI**), **switchDIM** or **DALI** (digital addressable lighting interface)
- error feed back and programmable features in both DALI and DSI mode
- integrated SMART interface

- fully electronic lamp management and digital communication with ASIC and  $\mu\text{C}$
- constant light output independent of fluctuating supply voltage
- DC operation in emergency lighting installations to VDE 0108
- safe shutdown of defective lamps
- safe shutdown of lamps at end of life (rectifying effect)
- automatic restart after lamp replacement
- operating frequency ~40–100 kHz

**Packaging:**  
box of 25  
28 boxes/pallet  
700 pieces/pallet

**Certified:**  
EN 55015  
EN 55022  
EN 60929  
EN 61000-3-2  
EN 61347-2-3  
EN 61547  
in accordance  
with VDE 0108

Lamp		Ballast										
watt- age W	length	type	article number	length L mm	fixing centres D mm	weight kg	circuit power W ②	lamp power W ②	current at 230V/50Hz A ②	$\lambda$ at 230V/50Hz	tc point °C	temperature range ① °C
14	549	PCA 1/14 T5 EXCEL 220/240V 50/60/0Hz	22084884	360	350	0.32	17.8	14	0.09	0.92	70	+10 → +60
2x14	549	PCA 2/14 T5 EXCEL 220/240V 50/60/0Hz	22084890	360	350	0.36	35.6	2x14	0.16	0.97	80	+10 → +60
21	849	PCA 1/21 T5 EXCEL 220/240V 50/60/0Hz	22084907	360	350	0.32	25.1	21	0.12	0.95	65	+10 → +60
2x21	849	PCA 2/21 T5 EXCEL 220/240V 50/60/0Hz	22084916	360	350	0.36	47.7	2x21	0.22	0.98	70	+10 → +60
28	1149	PCA 1/28 T5 EXCEL 220/240V 50/60/0Hz	22084540	360	350	0.32	32	28	0.15	0.96	70	+10 → +60
2x28	1149	PCA 2/28 T5 EXCEL 220/240V 50/60/0Hz	22084556	360	350	0.36	61	2x28	0.28	0.98	75	+10 → +60
35	1449	PCA 1/35 T5 EXCEL 220/240V 50/60/0Hz	22084569	360	350	0.32	38	34	0.17	0.97	75	+10 → +60
2x35	1449	PCA 2/35 T5 EXCEL 220/240V 50/60/0Hz	22084575	360	350	0.36	75	2x34	0.32	0.98	85	+10 → +60

① dimming to 1 % between 10 °C to  $t_{a \text{ max}}$ .

② valid at 100 % light output

**Lamp starting characteristics:**

Warm start  
Starting time 1.5 s with AC  
Starting time 0.6 s with DC  
Start at any dimming level

**AC operation:**

Mains voltage  
220–240 V 50/60 Hz  
198–264 V 50/60 Hz including safety tolerance ( $\pm 10\%$ )  
202–254 V 50/60 Hz including performance tolerance (+6% / -8%)

**DC operation:**

220–240 V 0 Hz  
198–280 V 0 Hz certain lamp start  
176–280 V 0 Hz operating range  
Use in emergency lighting installations according to VDE 0108 or for emergency luminaires according to EN 61347-2-3 appendix J.

**Temperature range:**

Dimming range 100 % to 1 % from 10 °C to maximum permissible ambient temperature  $t_a$ .

**Mains currents in DC operation:**

Ballast Type	Mains current at	
	$U_n = 220$ VDC	$U_n = 240$ VDC
PCA 1/14 T5 EXCEL 220–240V 50/60/0Hz	0.07 A	0.06 A
PCA 1/21 T5 EXCEL 220–240V 50/60/0Hz	0.10 A	0.09 A
PCA 1/28 T5 EXCEL 220–240V 50/60/0Hz	0.11 A	0.10 A
PCA 1/35 T5 EXCEL 220–240V 50/60/0Hz	0.14 A	0.13 A
PCA 2/14 T5 EXCEL 220–240V 50/60/0Hz	0.12 A	0.11 A
PCA 2/21 T5 EXCEL 220–240V 50/60/0Hz	0.18 A	0.16 A
PCA 2/28 T5 EXCEL 220–240V 50/60/0Hz	0.21 A	0.20 A
PCA 2/35 T5 EXCEL 220–240V 50/60/0Hz	0.27 A	0.25 A

**Light output level in DC operation:**

Programmable from 1 % to 70 %  
Programming by extended DSI signal (16 bit)  
Default value is 70 %  
In DC operation dimming is not possible

**Ballast lumen factor AC operation (AC-BLF) EN 60929 8.1:**

Ballast Type	AC-BLF at
	$U_n = 230$ VAC
PCA 1/14 T5 EXCEL 220–240V 50/60/0Hz	1.05
PCA 1/21 T5 EXCEL 220–240V 50/60/0Hz	1.00
PCA 1/28 T5 EXCEL 220–240V 50/60/0Hz	0.99
PCA 1/35 T5 EXCEL 220–240V 50/60/0Hz	1.00
PCA 2/14 T5 EXCEL 220–240V 50/60/0Hz	1.05
PCA 2/21 T5 EXCEL 220–240V 50/60/0Hz	0.98
PCA 2/28 T5 EXCEL 220–240V 50/60/0Hz	0.98
PCA 2/35 T5 EXCEL 220–240V 50/60/0Hz	0.98

The ballast lumen factor for AC operation (AC-BLF) does not alter from  $U_n = 198$  VAC to  $U_n = 254$  VAC.

The ballast lumen factor for DC operation (DC-BLF) on the basis of an automatic power reduction of the ballasts (default value is 70 %) will be smaller than AC. It does not alter in the DC operating range (198–280 VDC).

**Harmonic distortion in the mains supply (at 220 V/50 Hz):**

Ballast Type	THD					
		3	5	7	9	11
PCA 1/14 T5 EXCEL 220–240V 50/60/0Hz	9.0	8.6	2.3	1.6	1.3	1.0
PCA 1/21 T5 EXCEL 220–240V 50/60/0Hz	8.0	7.8	1.3	0.9	0.6	0.5
PCA 1/28 T5 EXCEL 220–240V 50/60/0Hz	12.4	11.6	3.7	2.1	1.5	1.1
PCA 1/35 T5 EXCEL 220–240V 50/60/0Hz	8.1	7.8	1.8	1.2	0.8	0.7
PCA 2/14 T5 EXCEL 220–240V 50/60/0Hz	10.6	10.3	2.2	1.3	1.0	0.8
PCA 2/21 T5 EXCEL 220–240V 50/60/0Hz	9.7	9.3	2.3	1.3	1.0	0.8
PCA 2/28 T5 EXCEL 220–240V 50/60/0Hz	6.0	6.0	0.8	0.4	0.3	0.3
PCA 2/35 T5 EXCEL 220–240V 50/60/0Hz	5.3	5.0	1.6	1.1	0.8	0.6

**Dimming:**

Dimming range 1 % to 100 %

Digital control with:

- DSI signal: 8 bit Manchester Code  
Maximum speed 1 % to 100 % in 1.4 s
  - DALI signal: 16 bit Manchester Code  
Maximum speed 1 % to 100 % in 0.5 s
- Programmable parameter:  
Minimum dimming level  
Maximum dimming level  
Default minimum = 1 %  
Programmable range  $1\% \leq \text{MIN} \leq 49\%$   
Default maximum = 100 %  
Programmable range  $100\% \geq \text{MAX} \geq 50\%$

Dimming curve that is friendly to the eye.

**Dimming characteristics PCA EXCEL**

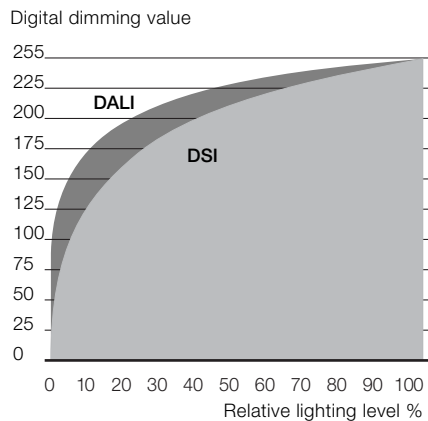

**Energy Savings PCA EXCEL**

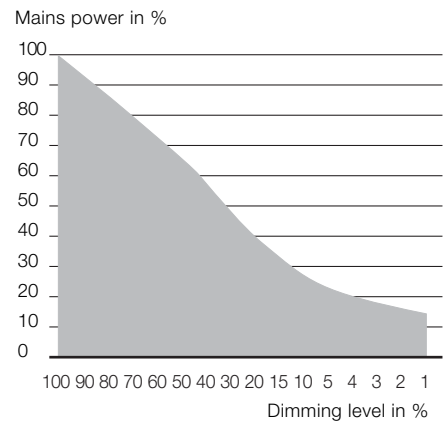

**Control input (DA/D1, DA/D2):**

Digital DALI/DSI signal or switchDIM can be wired on the same terminals (DA/D1 and DA/D2).

**Digital signal DALI/DSI:**

The control input is non-polar and protected against accidental connection with a mains voltage up to 264V. The control signal is not SELV. Control cable should be installed in accordance to the requirements of low voltage installations.

Different functions depending on each module.

Dimming with DALI or a DSI signal with the SMART-LS installed is not possible. switchDIM enables a temporary change of light level.

The installation of the two wire bus is according to the appropriate low voltage regulations.

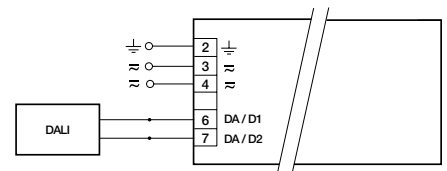

DALI PCA T5 EXCEL one4all

**SMART interface:**

An additional interface for the direct connection of the SMART-LS light sensor. The sensor registers actual ambient light and maintains the individually defined lux level.

After every mains reset the SMART interface automatically checks for an installed sensor. With the sensor installed the PCA EXCEL automatically runs in the constant lux level mode.

ON/OFF-Switch via mains, switchDIM or DALI/DSI signal.

DALI/DSI signal = 0 switches off,  
DALI/DSI signal  $\geq 1$  switches on.

**switchDIM:**

Integrated switchDIM function allows a direct connection of a push to make switch for dimming and switching.

Brief push (< 0.6 s) switches ballast ON and OFF. The ballasts switch-ON at light level set at switch-OFF.

When the push to make switch is held, PCA ballasts are dimmed. After repush the PCA is dimmed in the opposite direction.

In installations with PCAs with different dimming levels or opposite dimming directions (e.g. after a system extension), all PCAs can be synchronized to 50 % dimming level by a 10 s push.

Use of push to make switch with indicator lamp is not permitted.

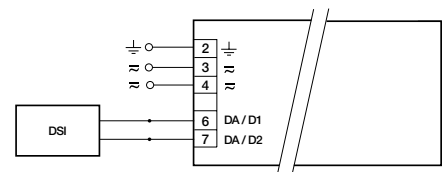

DSI PCA T5 EXCEL one4all

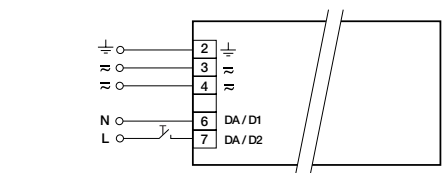

switchDIM PCA T5 EXCEL one4all

**Loading of automatic circuit breakers:**

Automatic circuit

breaker type	C10	C13	C16	C20	B10	B13	B16	B20
Installation Ø	1.5 mm <sup>2</sup>	1.5 mm <sup>2</sup>	1.5 mm <sup>2</sup>	2.5 mm <sup>2</sup>	1.5 mm <sup>2</sup>	1.5 mm <sup>2</sup>	1.5 mm <sup>2</sup>	2.5 mm <sup>2</sup>
PCA 1/14 T5 EXCEL	30	50	70	80	15	25	35	40
PCA 1/21 T5 EXCEL	30	50	70	76	15	25	35	38
PCA 1/28 T5 EXCEL	32	50	72	80	16	25	36	40
PCA 1/35 T5 EXCEL	32	50	70	80	16	25	35	40
PCA 2/14 T5 EXCEL	22	32	44	50	11	16	22	25
PCA 2/21 T5 EXCEL	22	32	44	50	11	16	22	25
PCA 2/28 T5 EXCEL	16	22	30	34	8	11	15	17
PCA 2/35 T5 EXCEL	16	22	30	34	8	11	15	17

**Electronic ballasts for dimming to 1 %  
Linear lamps T5, 16 mm high efficiency**

**Installation instructions:**

**Wiring type and cross section:**

The wiring can be solid cable with a cross section of 0.5 to 1.5 mm<sup>2</sup> for push terminal and 0.5 mm<sup>2</sup> for concut terminal. For the push-wire connection you have to strip the insulation (7.5–8.5 mm).

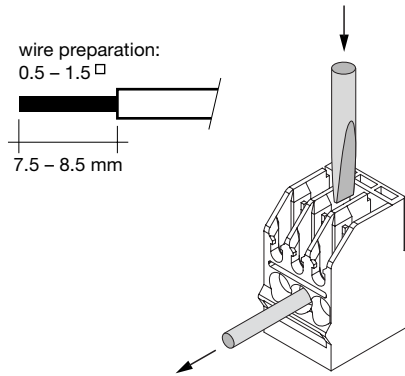

Ballast Type	U <sub>out</sub>
PCA 1/14 T5 EXCEL 220–240V 50/60/0Hz	250 V 250
PCA 1/21 T5 EXCEL 220–240V 50/60/0Hz	250 V 250
PCA 1/28 T5 EXCEL 220–240V 50/60/0Hz	400 V 400
PCA 1/35 T5 EXCEL 220–240V 50/60/0Hz	450 V 450
PCA 2/14 T5 EXCEL 220–240V 50/60/0Hz	250 V 250
PCA 2/21 T5 EXCEL 220–240V 50/60/0Hz	250 V 250
PCA 2/28 T5 EXCEL 220–240V 50/60/0Hz	400 V 400
PCA 2/35 T5 EXCEL 220–240V 50/60/0Hz	450 V 450

**RFI:**

- Connection to the lamps of the hot leads must be kept as short as possible
- Mains leads should be kept apart from lamp leads (ideally 5–10 cm distance)
- Do not run mains leads adjacent to the electronic ballast
- Twist the lamp leads
- Keep the distance of lamp leads from the metal work as large as possible
- Ballast must be earthed
- Mains wiring to be twisted when through wiring
- Keep the mains leads inside the luminaire as short as possible

**Important advise:**

- When using two or more dimmable ballasts in one luminaire with separate dimming controls, the lamp leads must be kept separate
- All lamps must have the same length lead

**Wiring advice:**

The lead length is dependent on the capacitance of the cable.

Ballast Type	Terminal		Maximum capacitance allowed	
	Cold	Hot	Cold	Hot
PCA 1/xx T5 EXCEL	11, 12	9, 10	200 pF	100 pF
PCA 2/xx T5 EXCEL	11, 12, 13, 14	9, 10, 15, 16	200 pF	100 pF

With standard solid wire 0.5/0.75 mm<sup>2</sup> the capacitance of the lead is 30–80 pF/m. This value is influenced by the way the wiring is made.

Lamp connection should be made with symmetrical wiring. Hot leads (9, 10, 15, 16) and cold leads (11, 12, 13, 14) should be separated as much as possible.

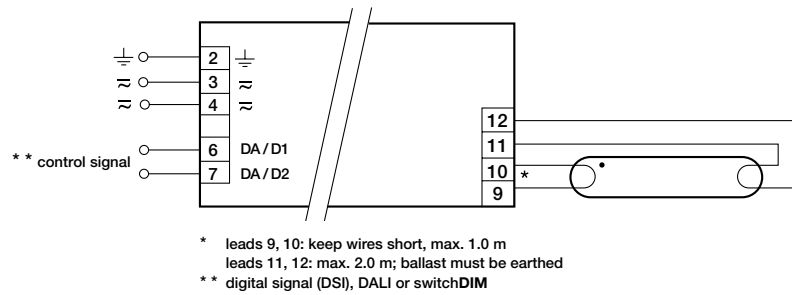

**PCA T5 EXCEL one4all 14–35 W**

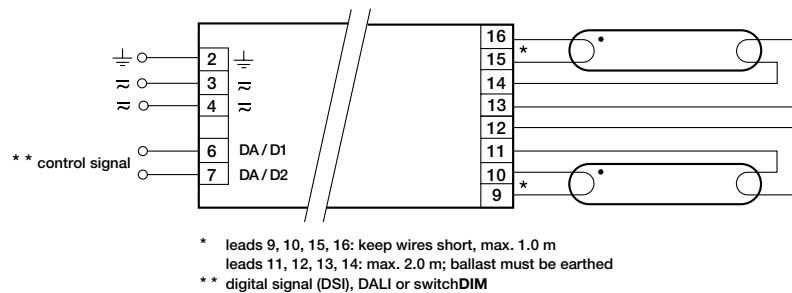

**PCA T5 EXCEL one4all 2x14–2x35 W**