

V-TAC®

INNOVATIVE LED LIGHTING

INSTALLATION INSTRUCTION

CCT BULKHEAD

WEEE Number: 80133970

MODEL	WATTS	LUMENS	BEAM ANGLE	LONG LIFE	BODY TYPE	ENVIRONMENTAL	INPUT POWER	DIMENSION	MICROWAVE SENSOR	EMERGENCY BATTERY BACKUP
VT-14SE	14W	1400 LM	120°	30,000 HOURS	PC	<80	AC: 200-240V, 50/60Hz	315x75mm	NO	YES
VT-14SES	14W	1400 LM	120°	30,000 HOURS	PC	<80	AC: 200-240V, 50/60Hz	315x75mm	YES	YES
VT-24SE	20W	1850 LM	120°	30,000 HOURS	PC	<80	AC: 200-240V, 50/60Hz	380x78mm	NO	YES
VT-24SES	20W	1850 LM	120°	30,000 HOURS	PC	<80	AC: 200-240V, 50/60Hz	380x78mm	YES	YES

EMERGENCY OPERATION TIME	EMERGENCY STANDBY WATTS	BATTERY CHARGING CURRENT	BATTERY DISCHARGING CURRENT	BATTERY TYPE	TEST BUTTON	CHARGING INDICATOR
>3 HOURS	>1.5 WATTS	60mA	200mA	Ni-CD, 9.6V 1.0Ah	YES	GREEN LED

INTRODUCTION & WARRANTY
Thank you for selecting and buying V-TAC product. V-TAC will serve you the best. Please read these instructions carefully before starting the installation and keep this manual handy for future reference. If you have any other query, please contact our dealer or local vendor from whom you have purchased the product. They are trained and ready to serve you at the best. The warranty is valid for 3 years from the date of purchase. The warranty does not apply to damage caused by incorrect installation or abnormal wear and tear. The company gives no warranty against damage to any surface due to incorrect removal and installation of the product. The products are suitable for 10-12 hours Daily operation. Usage of product for 24 hours a day would void the warranty. This product is warranted for manufacturing defects only.

WARNING!
1. Please make sure to turn off the power before starting the installation.
2. Installation must be performed by a qualified person.
3. The light source of this luminaire is not replaceable, when the light source reaches its end of life the whole luminaire should be replaced.
4. If the external flexible cable or cord of this luminaire is damaged, it shall be exclusively replaced by the manufacturer or its service agent or a similar qualified person in order to avoid a hazard.
This marking indicates that this product should not be disposed of with other household wastes. Caution, risk of electric shock.

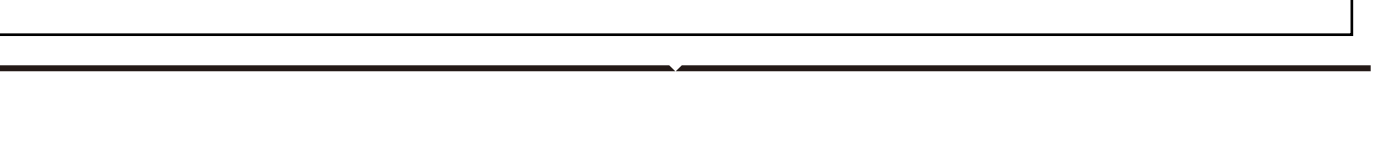
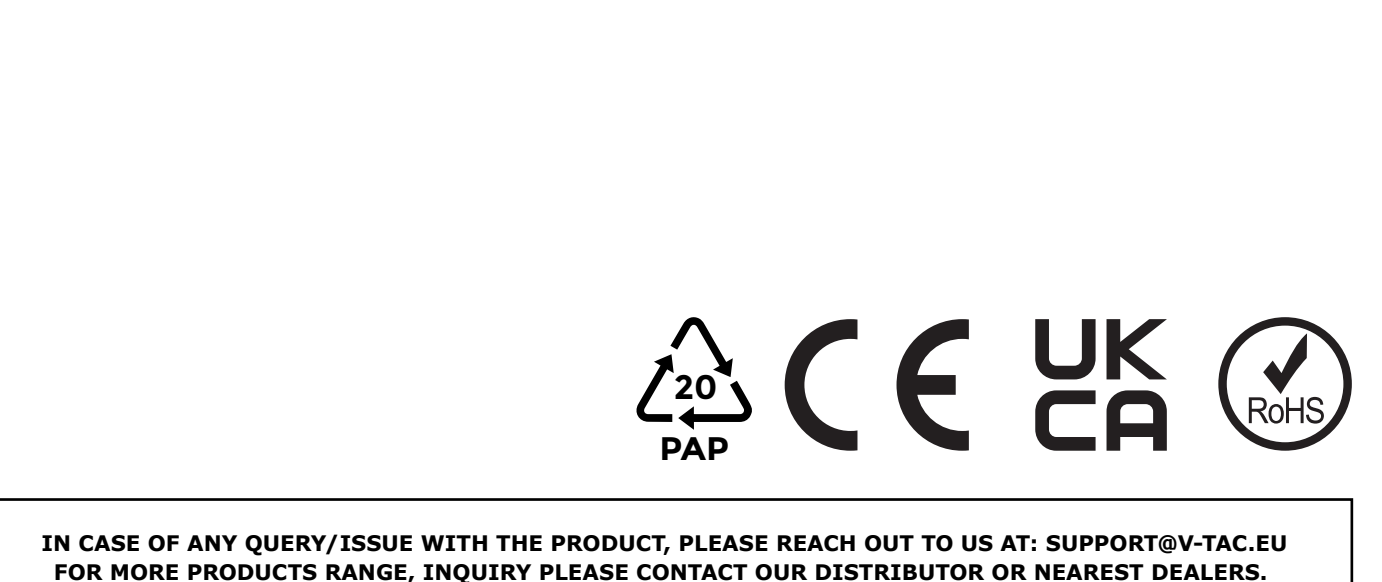
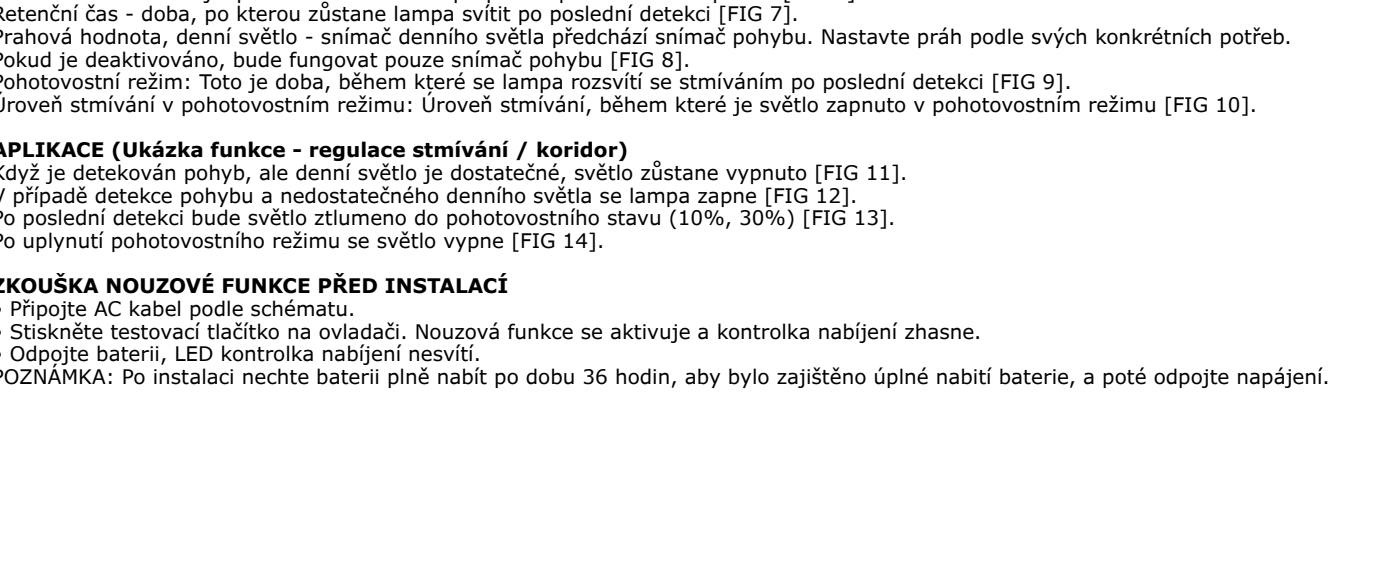
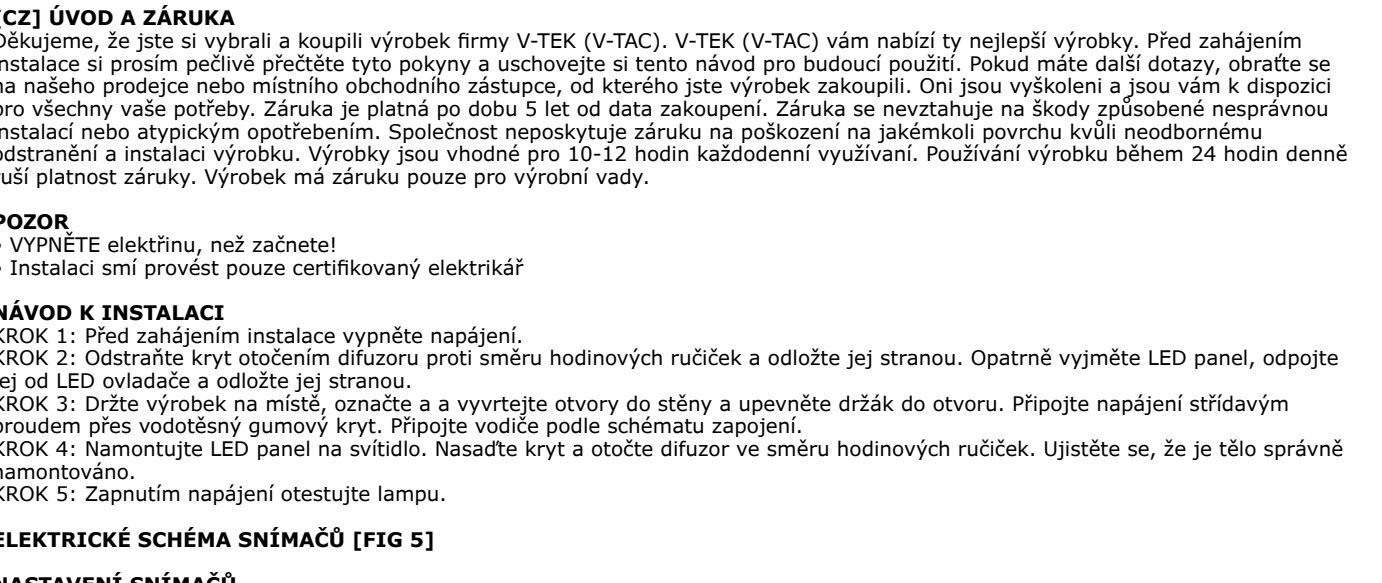
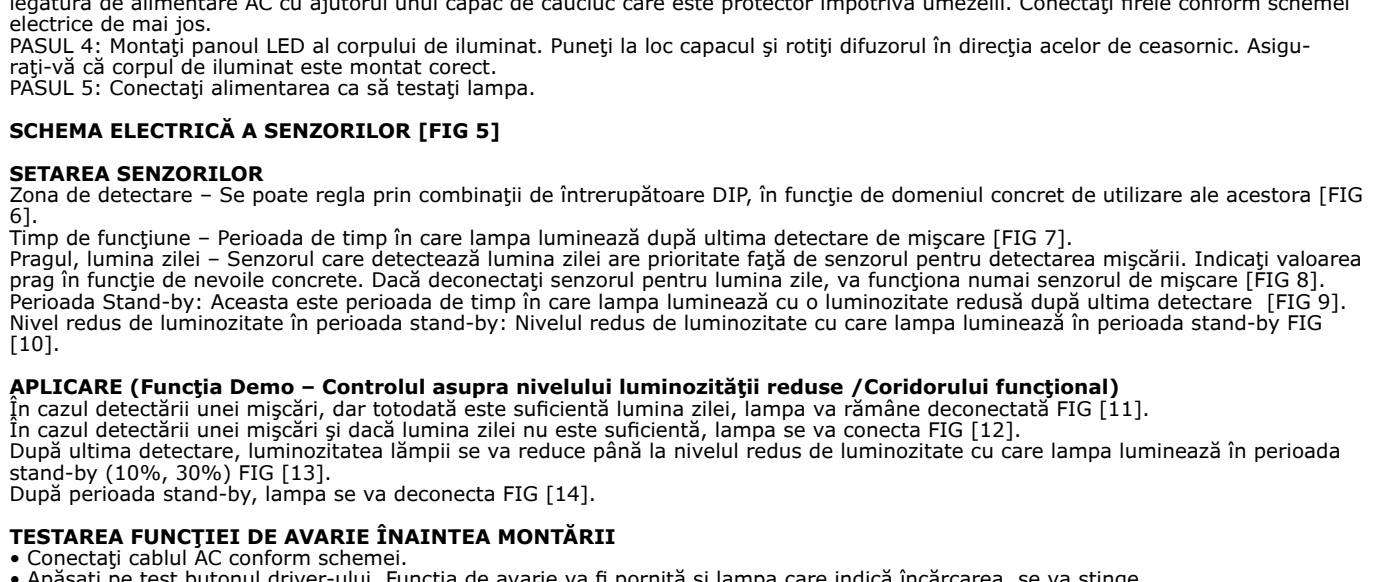
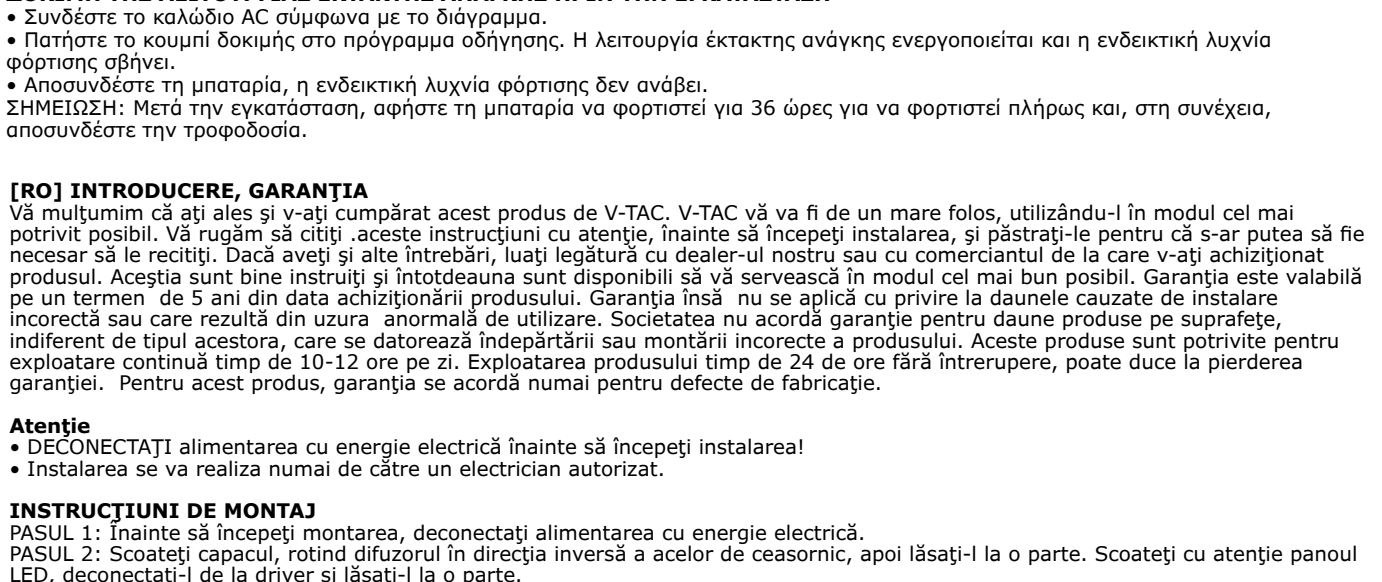
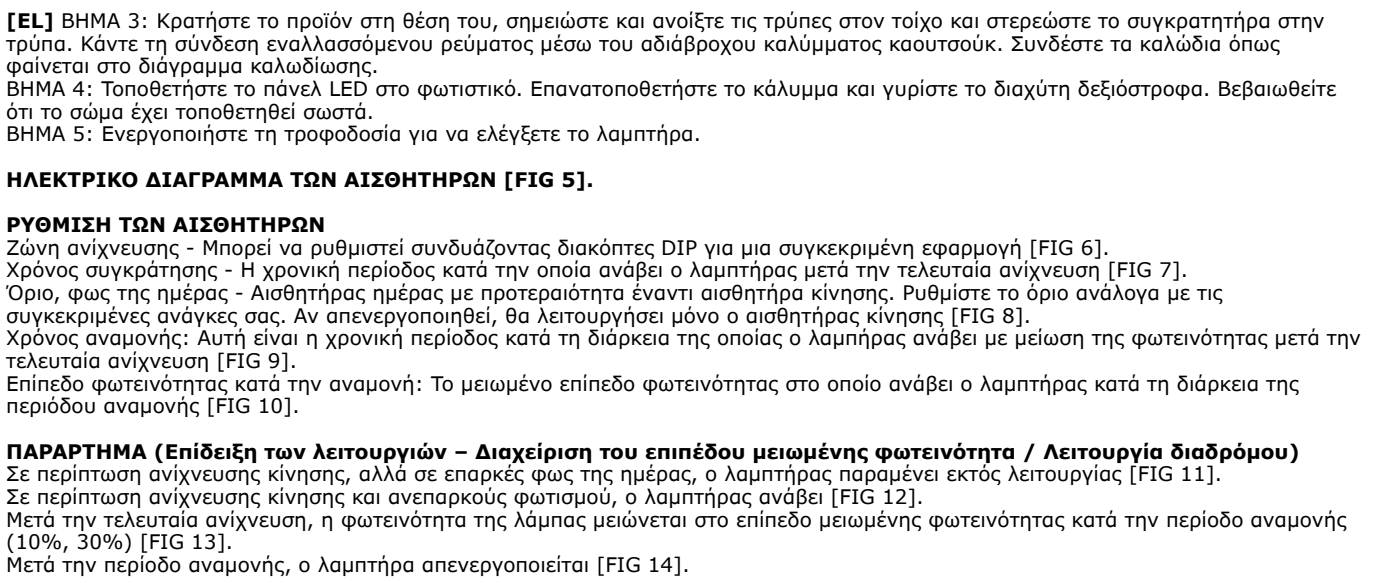
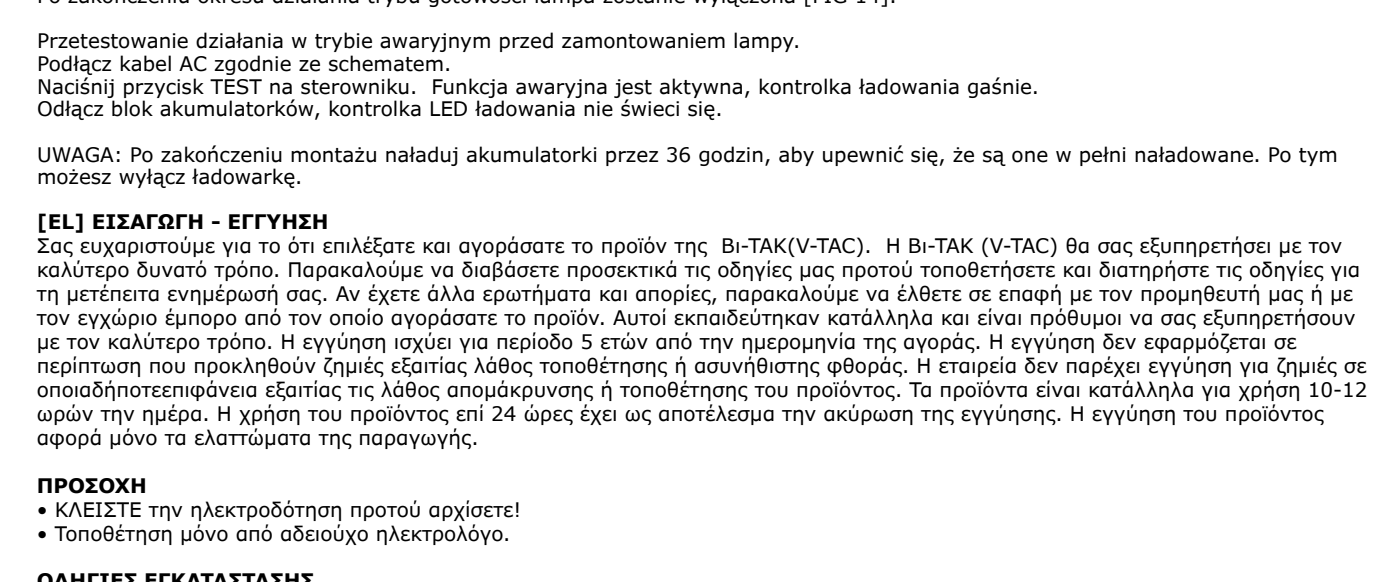
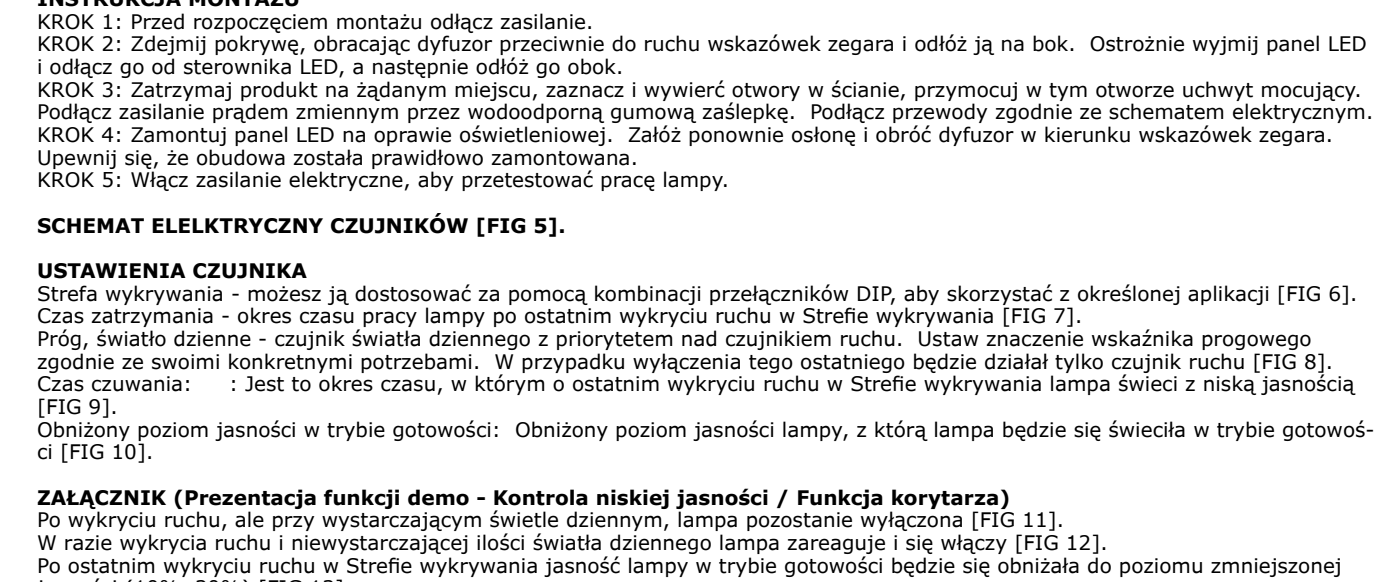
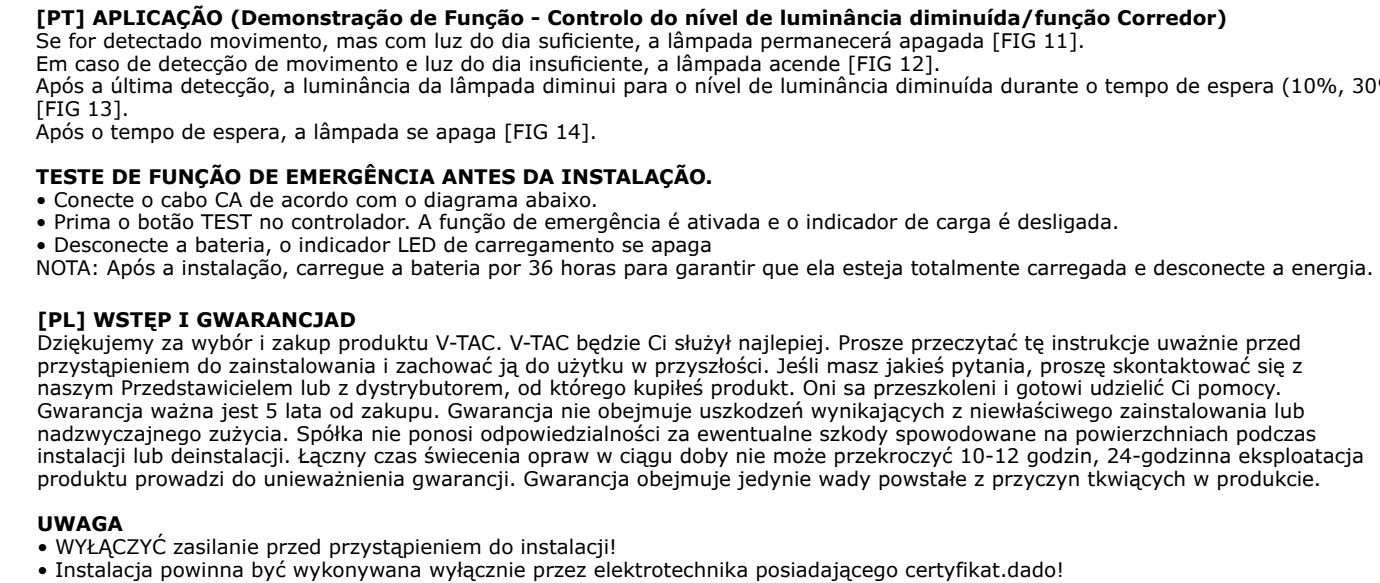
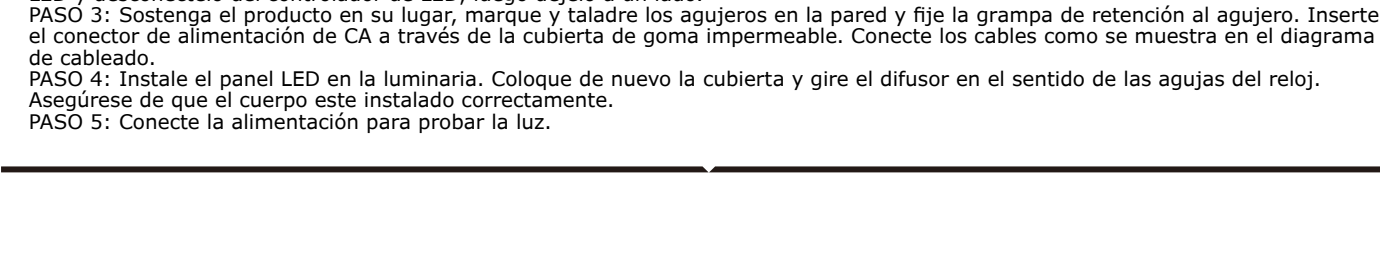
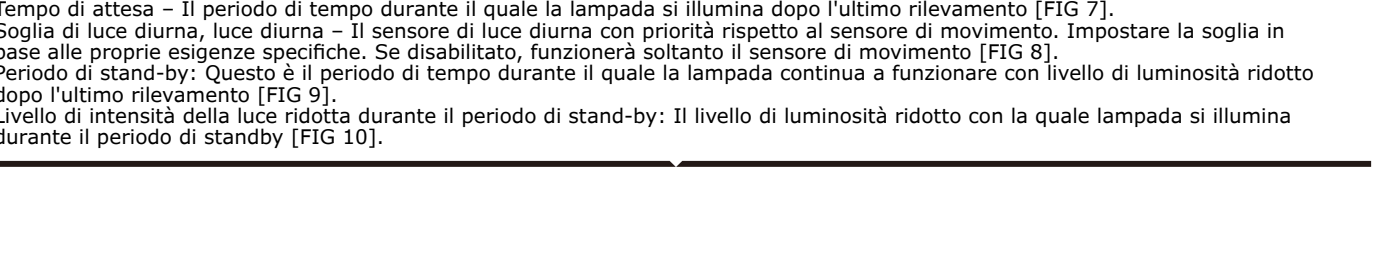
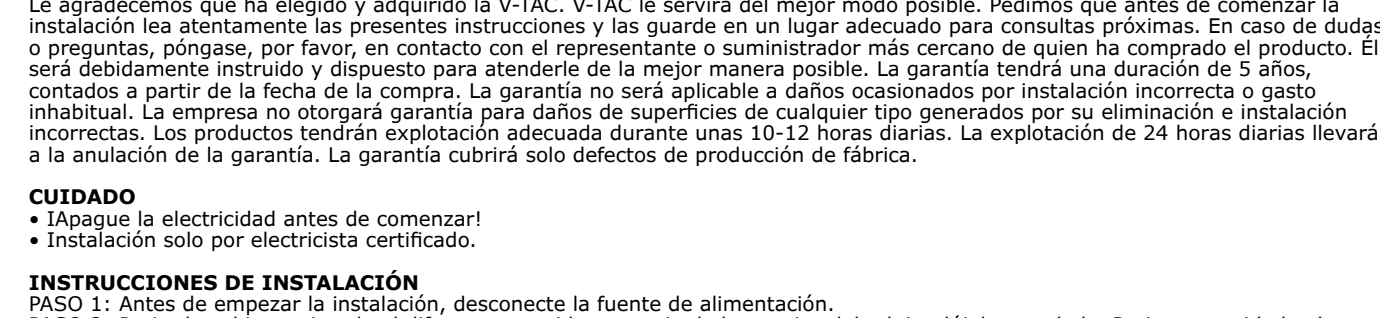
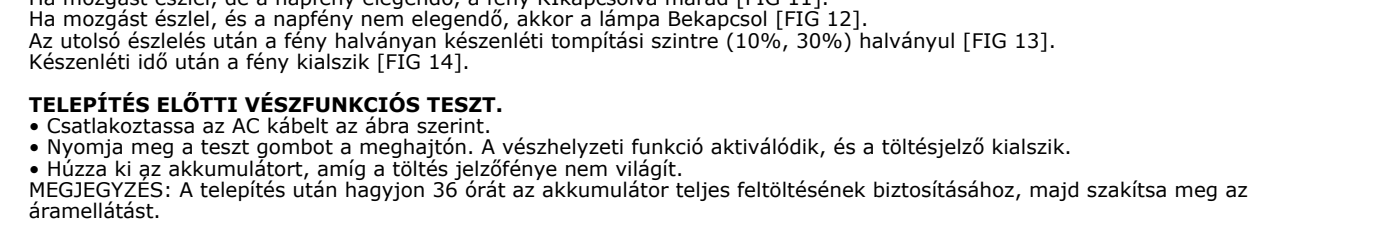
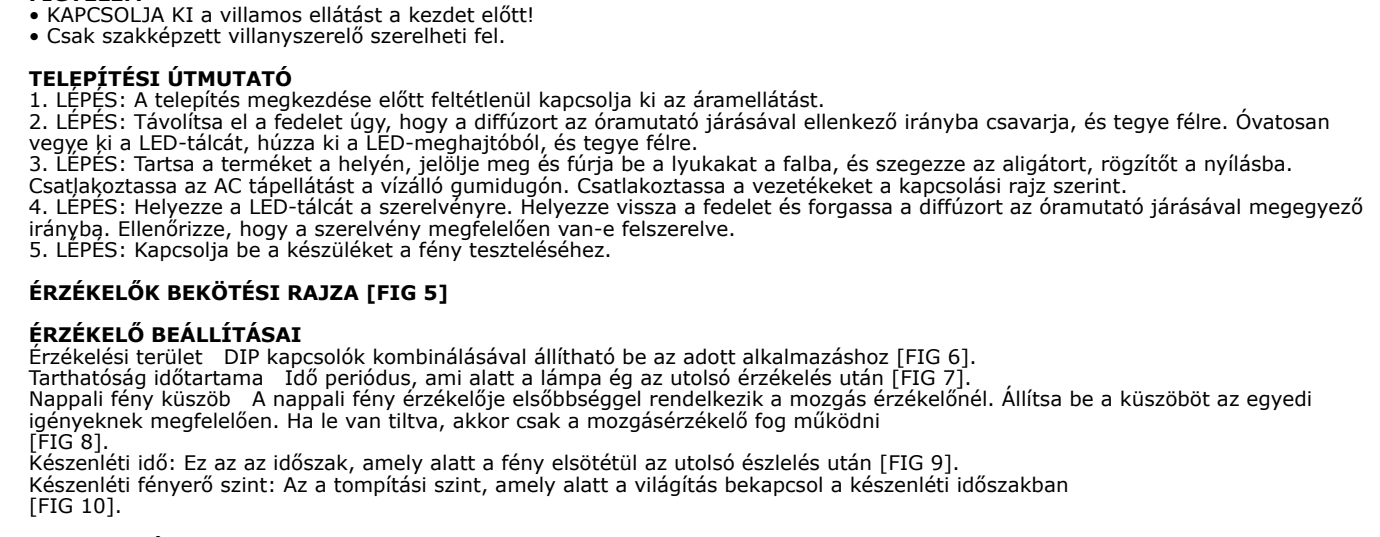
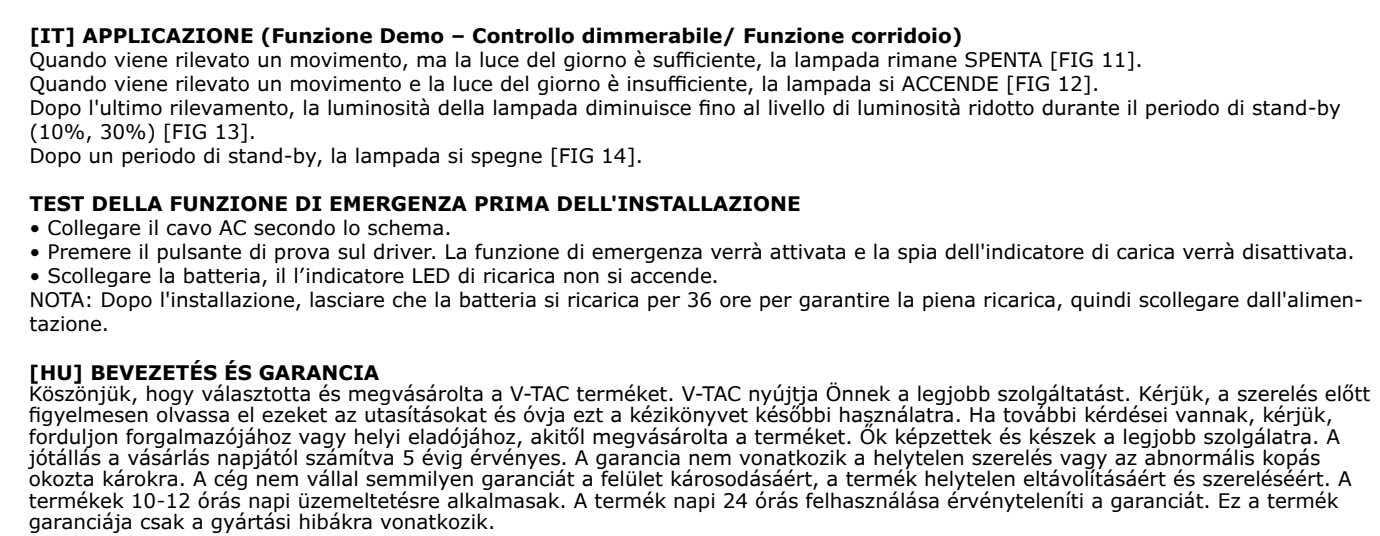
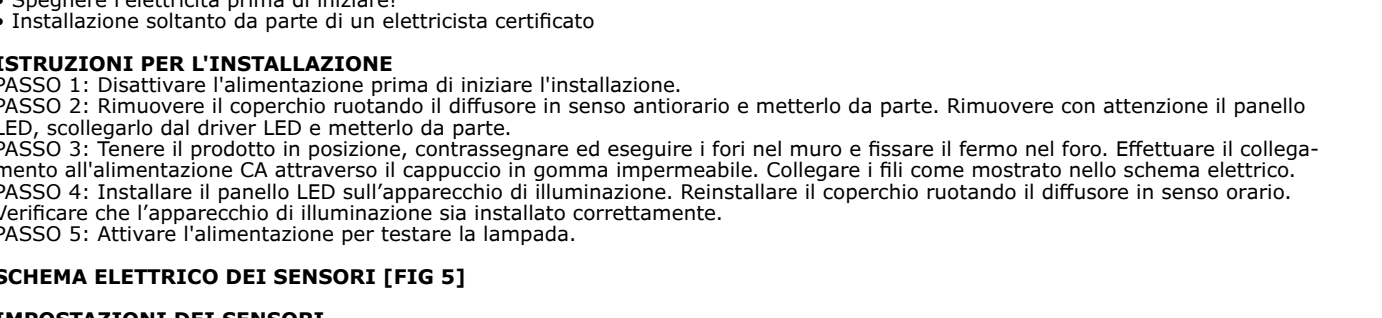
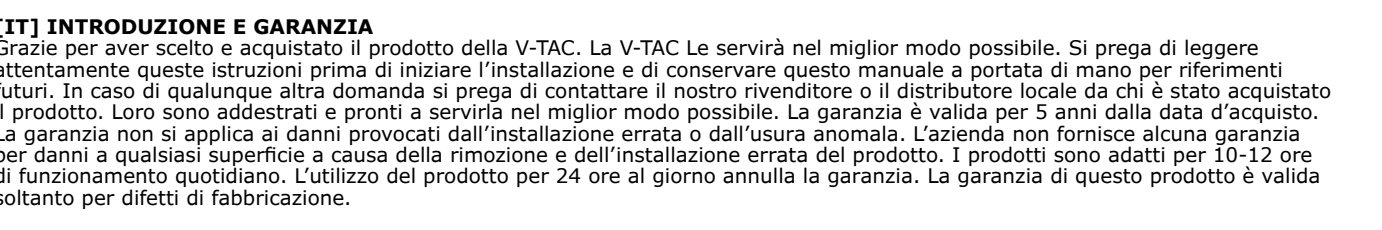
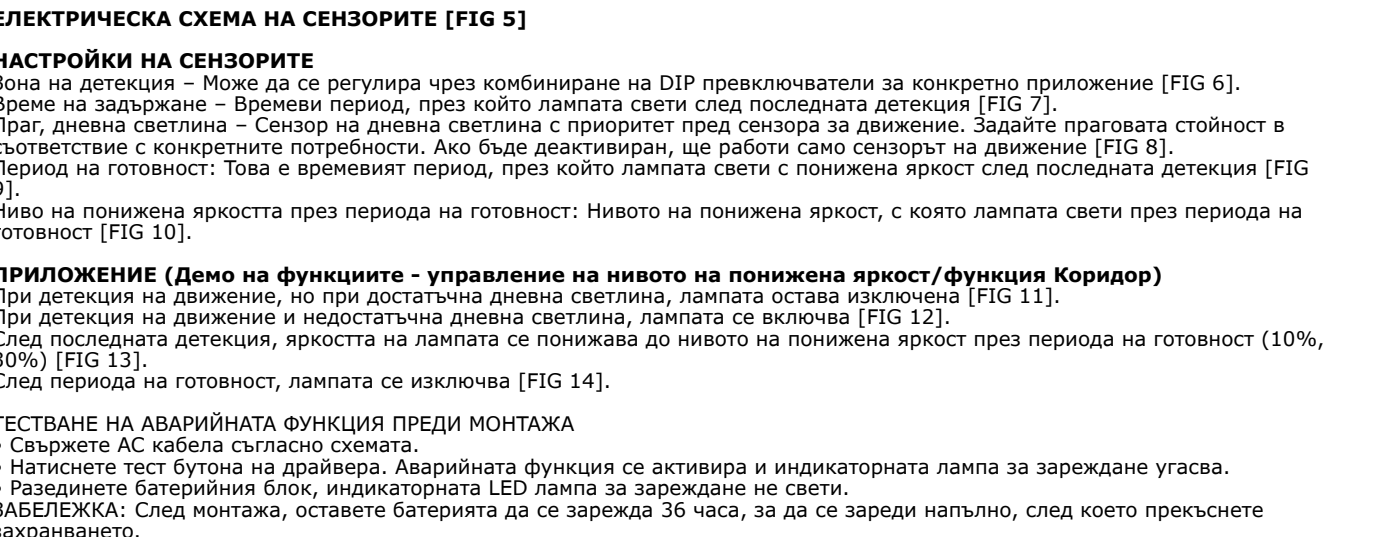
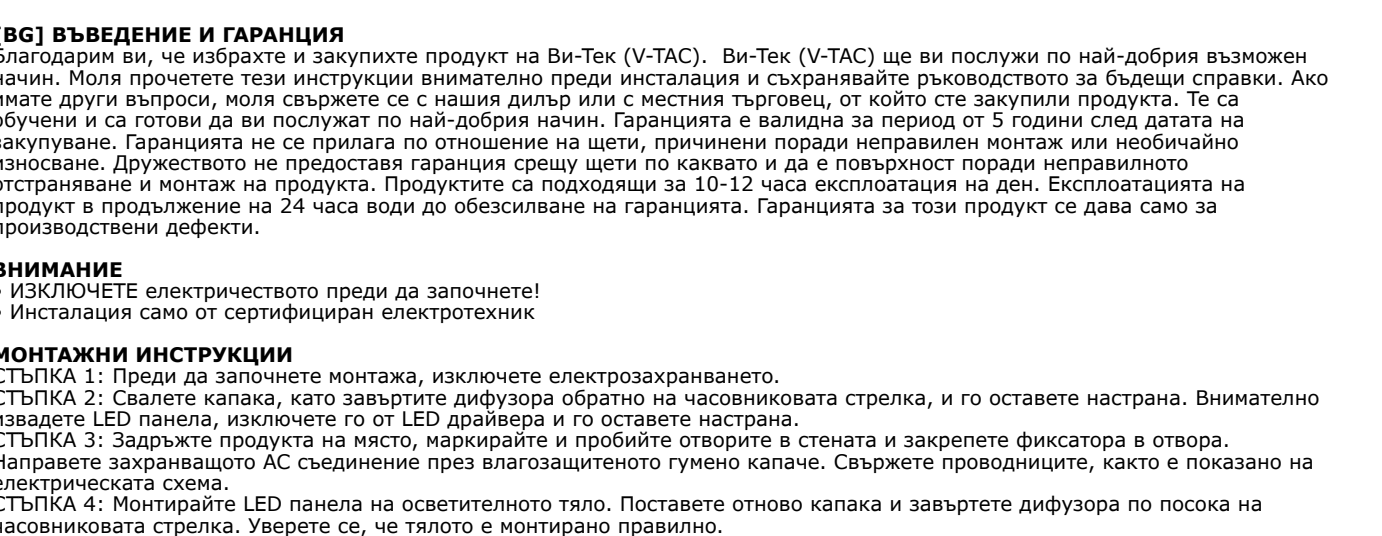
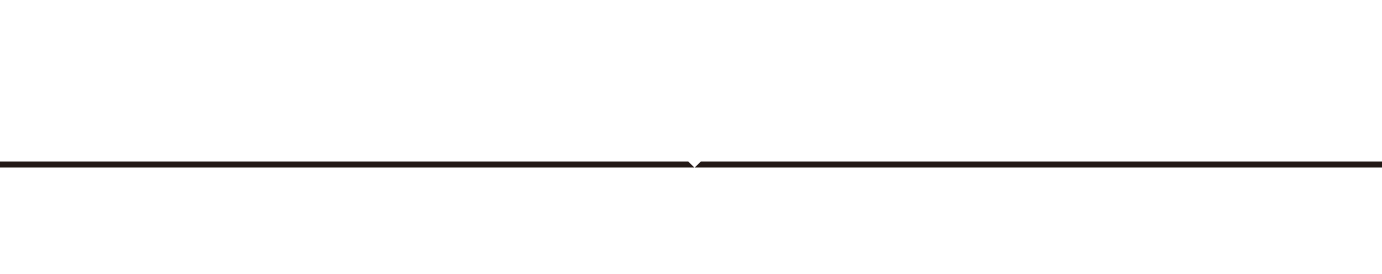
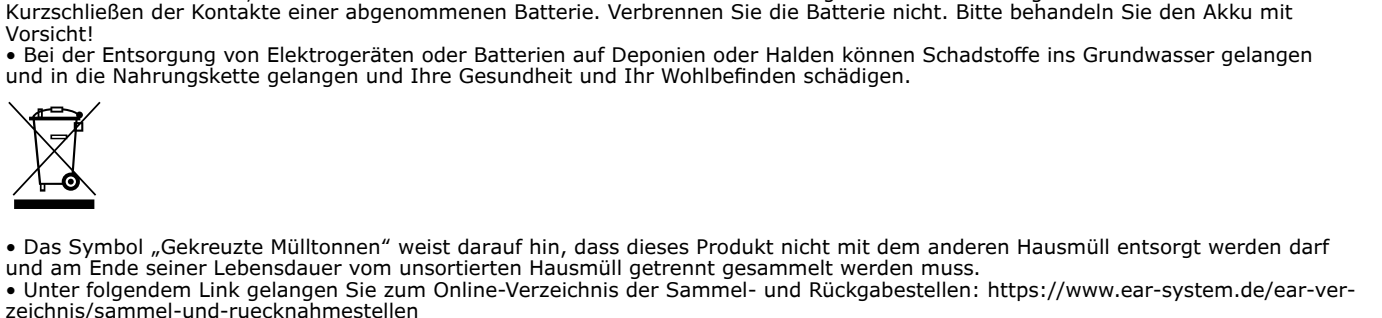
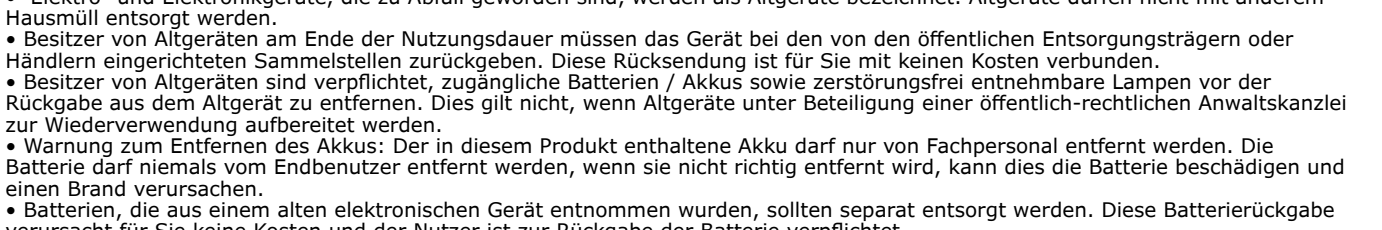
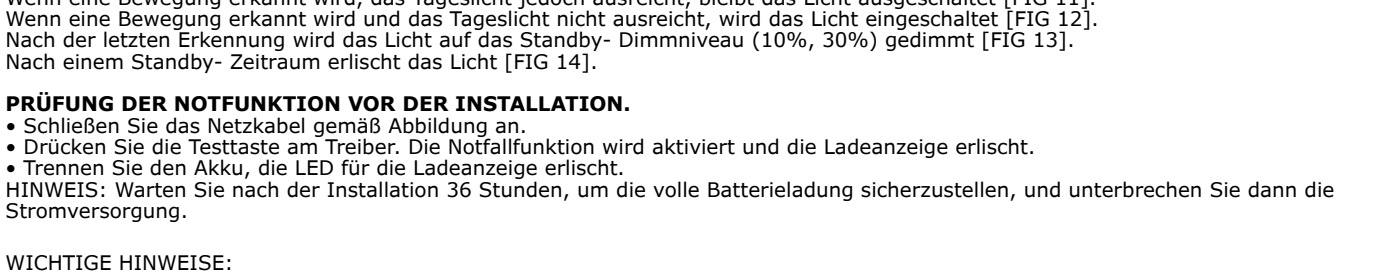
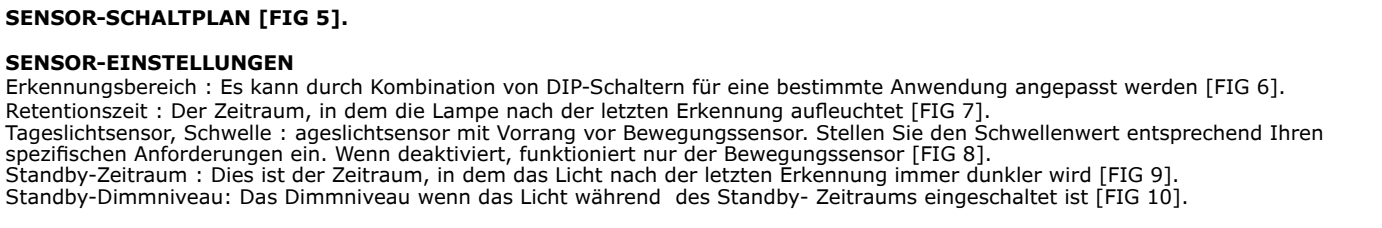
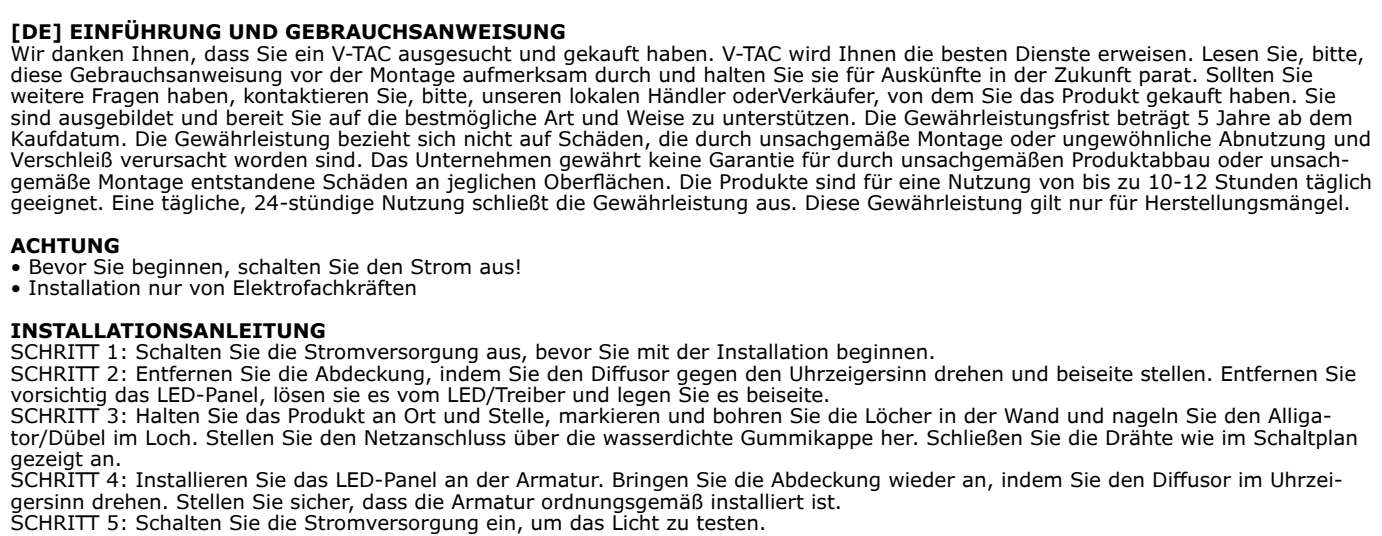
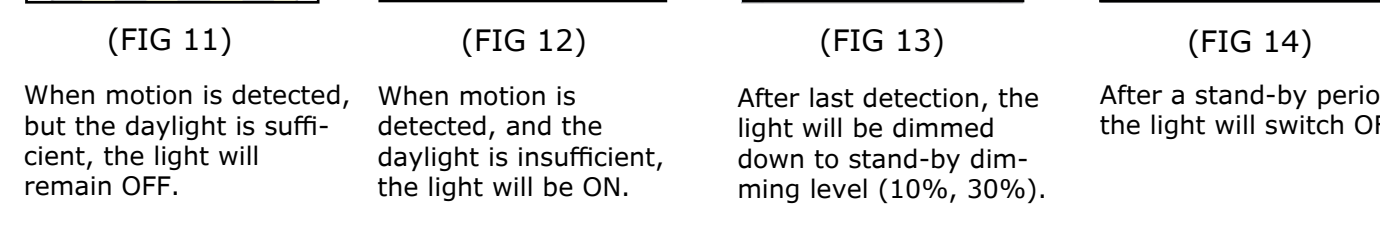
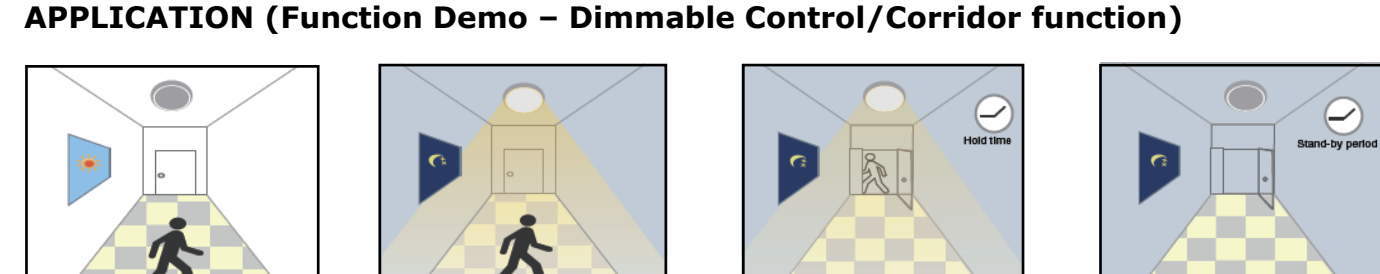
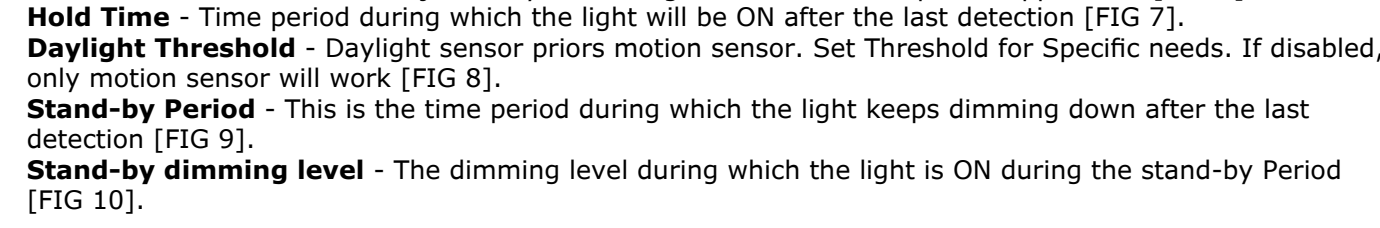
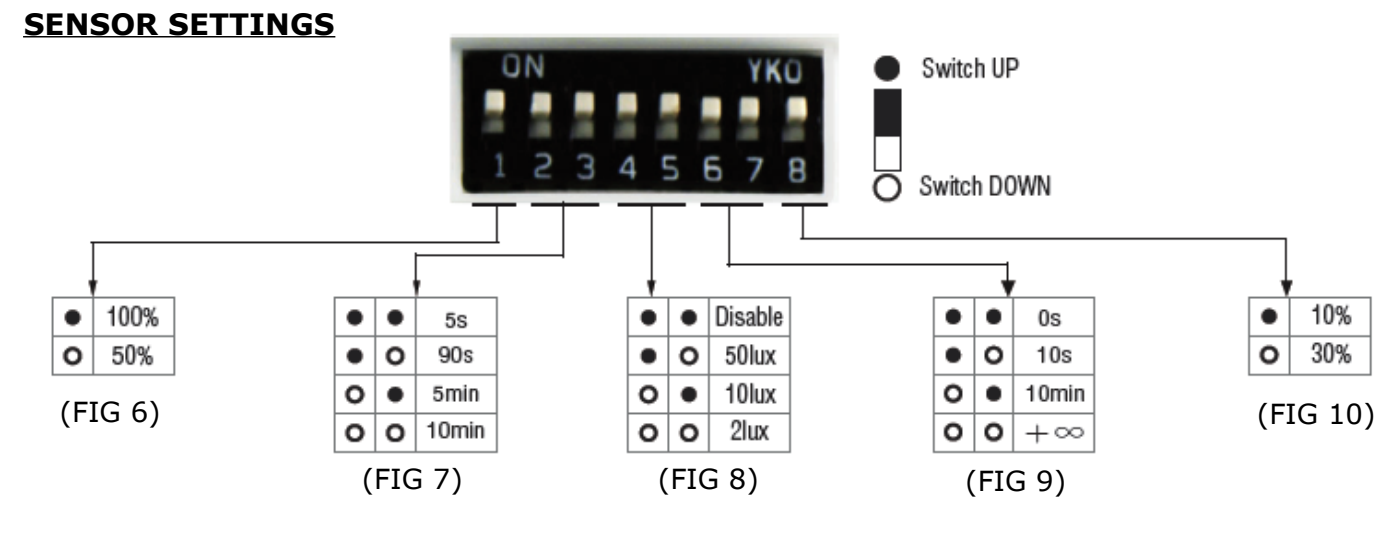
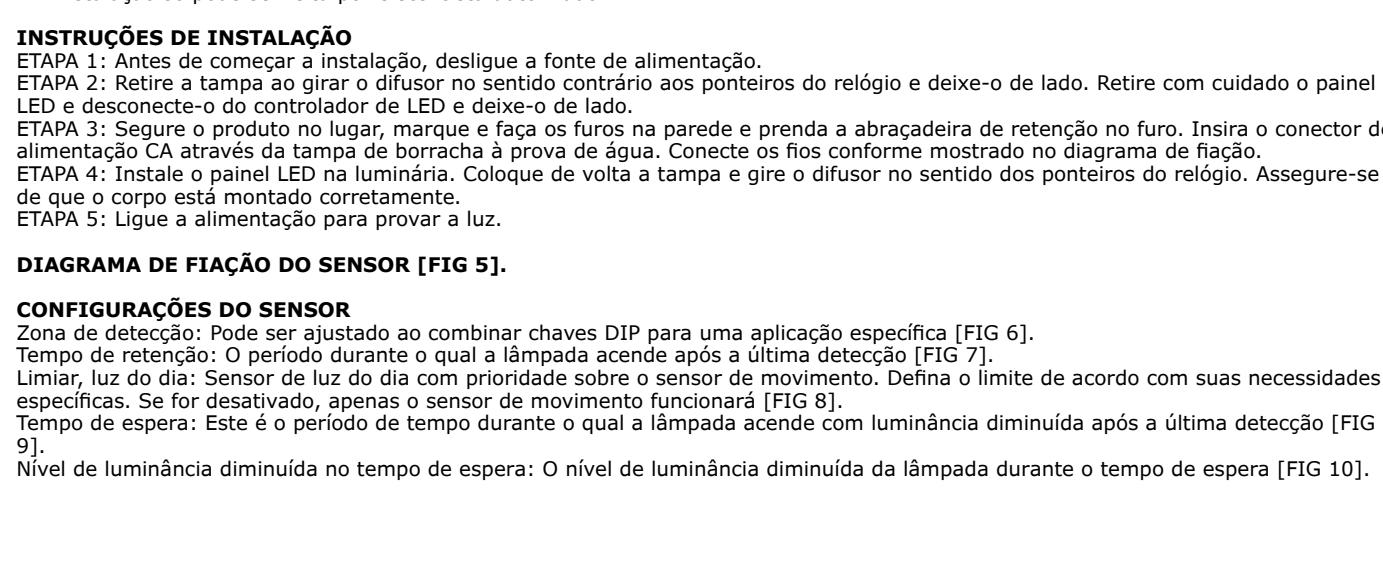
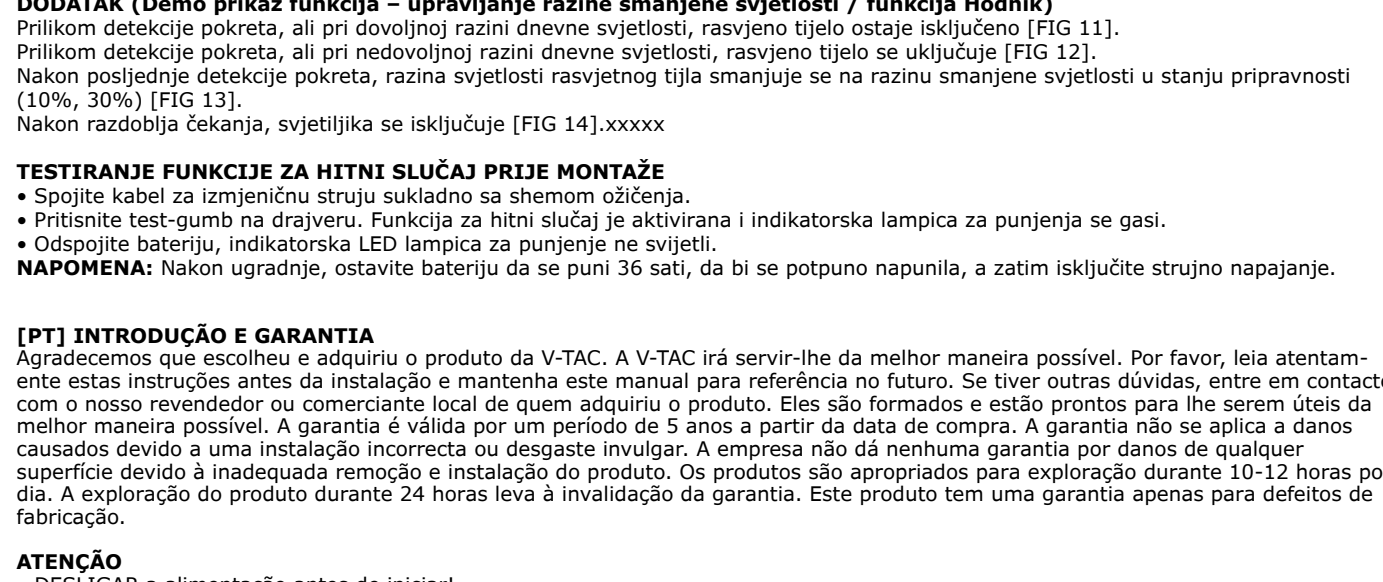
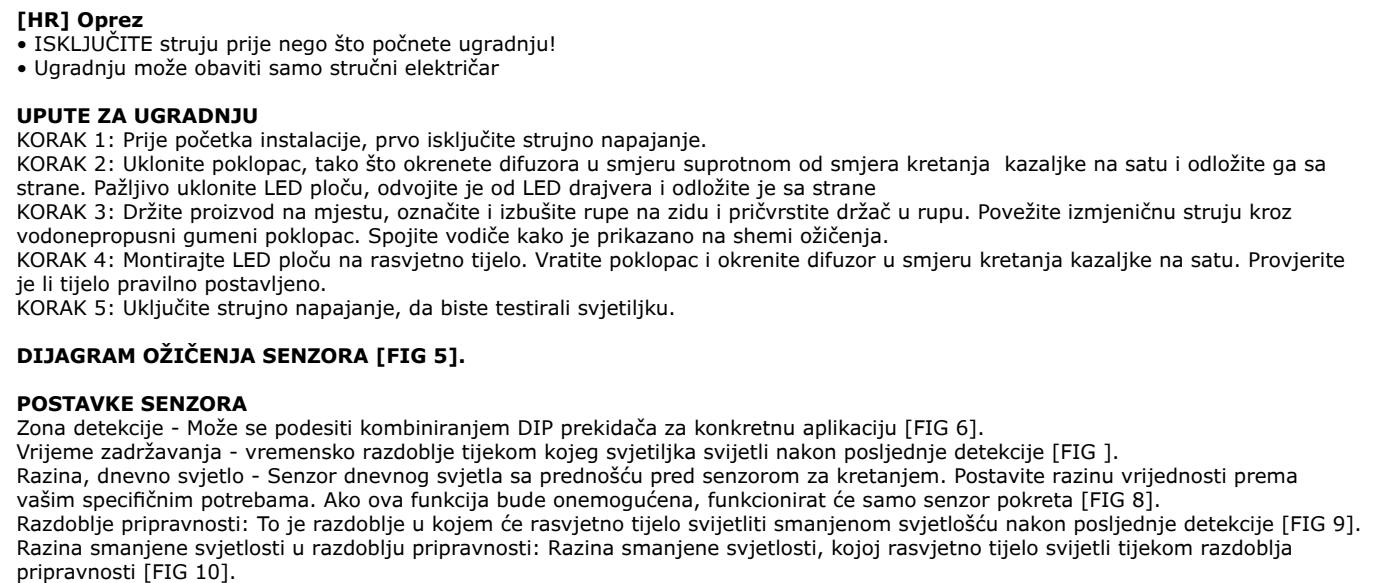
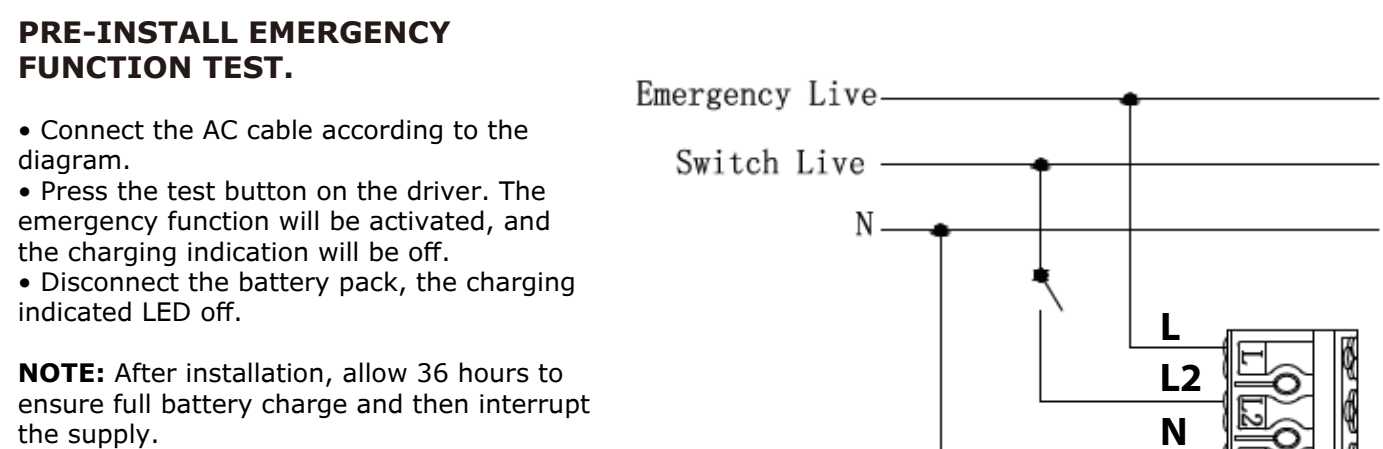
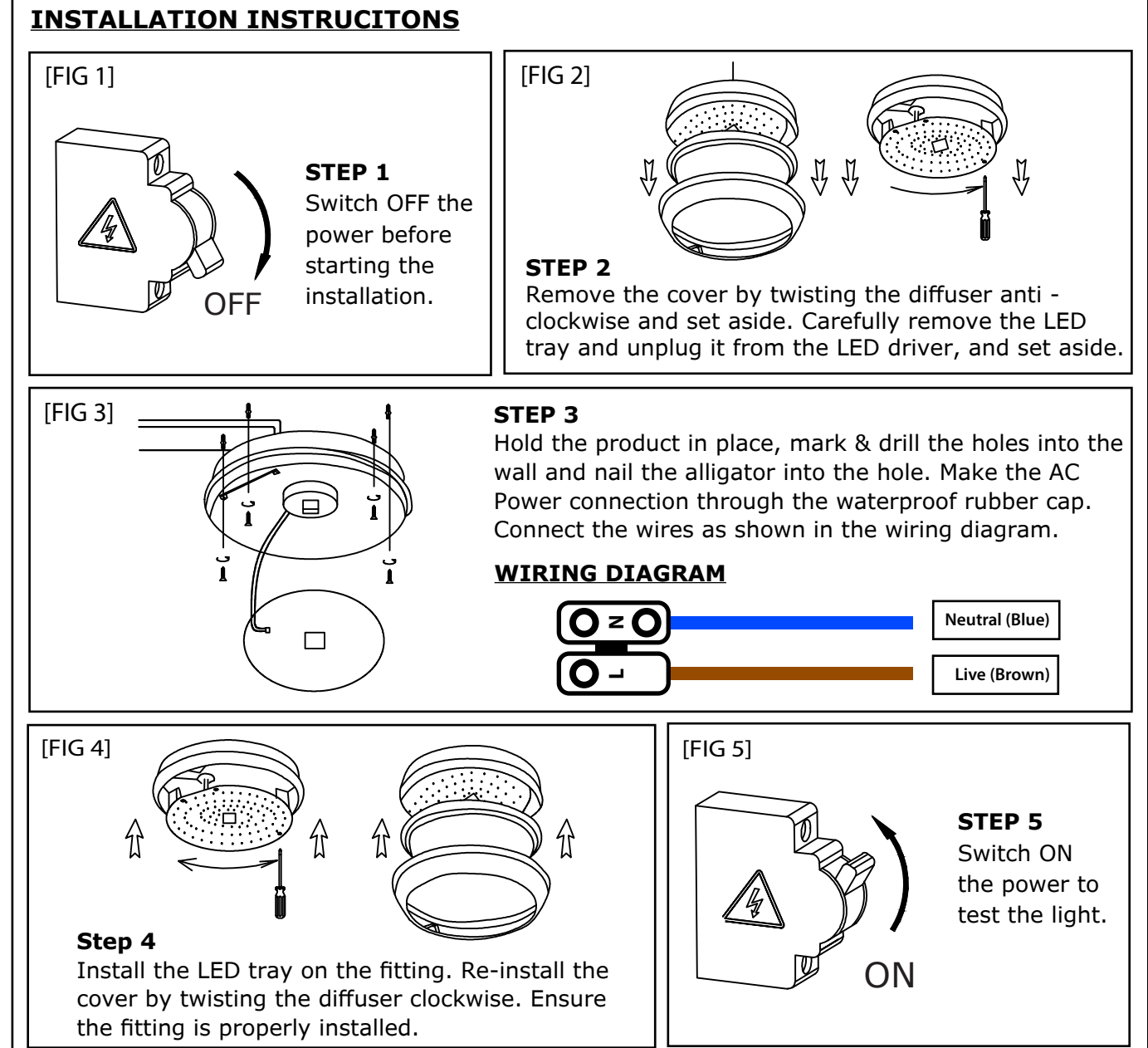

IN CASE OF ANY QUERY/ISSUE WITH THE PRODUCT, PLEASE REACH OUT TO US AT: SUPPORT@V-TAC.EU FOR MORE PRODUCTS RANGE, INQUIRY PLEASE CONTACT OUR DISTRIBUTOR OR NEAREST DEALER. V-TAC EUROPE LTD, BULGARIA, PLOVDIV 4000, BLV.KARAVELOV 9B